

Equipment Manual



Jack Table[™]

Platen Press

Equipment Manual

Jack Table[™]

Platen Press



U.S. and other patents pending.

MiTek
Machinery Division
301 Fountain Lakes Industrial Drive
St. Charles, MO 63301
Phone: 800-523-3380
Sales fax: 636-328-9222
Customer Service fax: 636-328-9218
www.mii.com

Part Number	001094
Date Created	1 August 2007
Created By	R. Widder
Reviewed By	R. Tucker
Approved By	G. McNeelege
Manuf. Eng.	K. Schuermann
Print Date	16 July 2008
Revision	A
Revision Date	3 January 2008
Revised By	R. Widder
Approved By	G. McNeelege
Applicability	30000-501, 30001-501, 30002-501, 30084-501
Effectivity	All

Legal Notice

Patents

Made and sold under one or more of the following patents:*

U.S. 37,797	U.S. 6,079,325	U.S. 6,405,916
U.S. 5,468,118	U.S. 6,145,684	U.S. 6,651,306
U.S. 5,454,687	U.S. 6,330,963	U.S. 6,807,903
U.S. 5,553,375	*Other patents pending	

Return Goods Policy

Return goods cannot be accepted without prior authorization and are subject to a restocking charge. The Seller certifies the articles specified herein were produced in compliance with all provisions of the Fair Labor Standards Act of 1938, as amended, including Section 12.—Rev. 6/98

Reporting Errors and Recommending Improvements

To report errors or recommend improvements to this manual, please complete the Document Evaluation Form in the appendices. Mail or fax the form to:

MiTek, Machinery Division
301 Fountain Lakes Industrial Drive
St. Charles, MO 63301
Attn: Engineering Manager
Fax: 636-328-9218

Your support in helping MiTek provide unsurpassed machinery and support is appreciated.

Contents

Preliminary Pages

Legal Notice	ii
Notice of Change	iii
Contents	iv

Safety (English)

Safety Indicators	ix
Safety Rules	x
Lockout/Tagout	xii
Lockout/Tagout Guidelines	xii
Electrical Lockout/Tagout Procedures	xiii
Troubleshooting With an Energized Machine	xvi
Restricted Zone	xvii
Safety Test	xviii

Seguridad (Español)

Indicadores de seguridad	xx
Reglas de seguridad	xxi
Bloqueo/Etiquetado	xxiv
Pautas de bloqueo/etiquetado	xxiv
Procedimiento de bloqueo/etiquetado de sistema hidráulico	xxvii
Solución de problemas con una máquina energizada xxix	
Zonas restringida	xxx
Prueba de seguridad	xxx

Introduction

Chapter 1

Introduction to the Manual	1
Purpose and Scope of This Equipment Manual ...	1
Navigation	2
Additional Resources	3
Supplemental Documentation	3
Web Site	3
Contacting MiTek	3

General Information

Chapter 2

Introduction to the Equipment	4
Purpose of the Equipment	4
Description of the Equipment	4
Main Components and Optional Equipment	6
General Specifications	7
Truss Terminology	8

Prior to Installation

Chapter 3

MiTek's Responsibilities	10
Prior to Installation	10
During Installation	10
Customer Responsibilities	11
Location Requirements	13

Contents

Electrical Requirements	14
Shipping Information	15
Customer-Supplied Parts	16
Training Provided	16
Installation	Chapter 4
Responsibilities During Installation	17
Delivery	17
Checking for Damage	17
Unloading	18
Equipment Layout	19
Installing the Jack Table	19
Placing the Table	19
Anchoring the Table	19
Leveling the Table	20
Hydraulic System	21
Hydraulic Fluid	21
Connecting the Hoses	21
Electrical Connections to the HPU	21
Electrical System	22
Checking Existing Wiring	22
Connecting Power to the Equipment	22
Installation Checklist	23
Startup	Chapter 5
Preparing the Hydraulic System	24
Checking Motor Rotation	24
Safety Tests	24
Operation	Chapter 6
Before You Begin	25
Safety Operating Notes	25
Starting the Machine	27
Indicators	27
Operator Control Interface	28
Operating Procedure	29
Procedure Under Normal Conditions	29
Restart Procedure	30
Hydraulic System Operation	31
Hydraulic System Overview	31
Operating Overview	31
Maintenance	Chapter 7
Introduction to Maintaining Your Equipment	32
Performing Maintenance Safely	33
Before Operating This Equipment	33
Lockout/Tagout	33
Making Adjustments	34
Replacing Parts	34

Contents

Wearing Personal Protective Equipment	34
Conducting Safety Tests	34
Overview Graphics	35
Operating Procedures for Maintenance Personnel	36
Adjustments	37
Adjusting the Pressing Height	37
Adjusting the Finger Guide Bars	37
Cleaning, Lubricating, and Inspecting	39
Cleaning	39
Lubricating	39
Lubricating With Grease	40
Lubricating With Oil	40
Inspecting	40
Hydraulic System	41
Hydraulic Fluid Specifications	41
Checking and Adding Hydraulic Fluid	41
Replacing the Filter Element	42
Replacing the Hydraulic Fluid	42
Replacing the Hydraulic Cylinders	48
Replacing the Hydraulic Pump	49
Replacing the HPU Electric Motor	50
Hydraulic Adjustments	51
Bearings	53
Drive Shaft Bearings	53
Replacing the Drive Shaft Bearings	53
Wheels	56
Replacing the Drive Wheels	56
Replacing the Support Wheel Die Spring	59
Chains	60
Lubricating Chains	60
Adjusting the Motor Drive Chain Tension	60
Wear Strips	62
Replacing the Finger Guard Wear Strips	62
Replacing the Guide Bar Wear Strips	63
Replacing the End Guide Bar Wear Strips	63
Jigging and Blocking	65
Available Jigging	65
Stocking Replacement Jigging	65
Replacing the Blocking	66
Bumpers	67
Electrical Components	68
Replacing Light Bulbs	68
Motor Starters and Overloads	68
Troubleshooting	
Appendix A	69
Parts List	
Appendix B	76

Contents

Maintenance Checklists	
Appendix C	79
Technical Information	
Appendix D	83
Drawing Set	
Appendix E	95
Document Evaluation	
Appendix F.....	96
Glossary	99
Index	101

Safety (English)

For safety information in Spanish, refer to page xix.

**Be Careful.
Be Safe.**



Safety Indicators

The following safety alert symbols and signal words are used throughout this document to indicate safety hazards. Please pay careful attention when you see them. The level of severity differs for each symbol or signal word.

Failure to comply with the instructions accompanying each safety alert symbol may result in property damage, personal injury, or even death. Personnel must follow all safety procedures and practices to ensure the safest possible operation of this equipment. However, at no time is this document a substitute for common sense. Personnel must ensure that the work environment is safe and free of distractions.



DANGER

Indicates an imminently hazardous situation which, if not avoided, is likely to result in death or serious injury.



WARNING

Indicates a potentially hazardous situation which, if not avoided, may result in death or serious injury.



CAUTION

When CAUTION is used **with** the safety alert symbol shown here, it indicates a potentially hazardous situation which, if not avoided, may result in minor or moderate injury.

When CAUTION is used **without** the safety alert symbol shown here, it indicates a potentially hazardous situation which may result in equipment damage.

NOTICE

NOTICE

Calls attention to information that is significant to understanding the operation at hand.

ENVIRONMENTAL

ENVIRONMENTAL

Applies to conditions that may affect the environment but do not have an immediate, direct effect on personnel or equipment.

Safety Rules

Because it is impossible to anticipate every circumstance that might involve a hazard, the safety information provided in this equipment manual and on the machine is not all-inclusive. If this machine is operated or serviced using a procedure not specifically recommended by the manufacturer, the procedure shall be approved by a professional engineer to ensure it will not render the equipment unsafe. Use extreme caution and common sense at all times!

Know Your Equipment

- Read this manual completely before using or maintaining the equipment. Do not operate this machine unless you have a thorough knowledge of the controls, safety devices, emergency stops, and operating procedures outlined in this manual.
- Read and follow all safety notes. Failure to comply with these instructions may result in economic loss, property damage, and/or personal injury including death.
- Refer to the lockout/tagout guidelines on the following pages to safely perform maintenance and troubleshooting of this equipment.
- Observe and obey all safety labels. Replace worn labels immediately.
- Use this equipment solely for the purpose described in this manual.
- Only qualified personnel should attempt to operate or perform maintenance on this equipment. “Qualified personnel” is defined as:

...a person or persons who, by possession of a recognized degree or certificate of professional training, or who, by extensive knowledge, training, or experience, has successfully demonstrated the ability to solve problems relating to the subject matter and work—ANSI B30.2-1983

...one who has skills and knowledge related to the construction and operation of the electrical equipment and installations and has received safety training on the hazards involved—NEC 2002 Handbook

Personal Safety

- Always wear safety glasses and hearing protection in an industrial environment.
- Utilize a filtering facepiece (dust mask) when working near sawdust.
- Wear proper clothing and appropriate personal protective equipment (e.g., safety glasses and hearing protection.) Do not wear loose clothing or jewelry. Confine long hair by tying it back.
- Use caution when lifting heavy parts or material.

Installing the Equipment

- Follow installation instructions completely.

Lockout/Tagout

- Before performing maintenance on the pneumatic or hydraulic systems, bleed the lines to eliminate pressure.
- Lockout/tagout all energized systems before performing maintenance on them. Refer to the *Lockout/Tagout Guidelines* section on page xii.

Keeping a Safe Environment

- Keep children away. All visitors should be kept a safe distance from the work area. Hazards may not be apparent to individuals unfamiliar with the machine.
- Keep work areas well lit.
- Keep the work area clean and free of any trip or slip hazards.
- Do not use the equipment in damp or wet locations, or expose it to rain or snow.

Operating and Maintaining the Equipment

- Ensure that all people, tools, and foreign objects are clear of the restricted zones before operating this equipment. The restricted zones are shown on page xvii.
- Perform safety tests to ensure all E-stops are working properly before operating the equipment at the initial startup, after performing any maintenance, and in accordance with the maintenance schedule.
- In case of machine malfunction, stop the machine immediately using an E-stop and report the malfunction to a supervisor.
- Never leave the machine running unattended. Turn the power off! Do not leave the machine until all parts have come to a complete stop and all electrical power has been shut off.
- Check for worn or damaged parts regularly. Repair or replace them immediately.
- Keep the hydraulic, pneumatic, and electrical systems in good working order at all times. Repair leaks and loose connections immediately. Never exceed the recommended pressure or electrical power.
- Check that all safety devices are in working order before each shift starts. All protective guards and safety devices must be in place before and during use of the machine. Never disconnect or bypass any safety device or electrical interlock.
- Periodically inspect the quality of the finished product.

Electrical Safety

- Do not use any liquids in the interior of electrical cabinets.
- When using solvents on and around the machine, remove power to the machine to eliminate the chance of sparking, resulting in explosion or fire. Wear a respirator approved for use with solvents. Wear protective clothing, gloves, and safety glasses.

Lockout/Tagout

Lockout/Tagout Guidelines

All lockout/tagout guidelines must be met according to OSHA 29 CFR 1910.147. A specific procedure should be included in your company's energy control program. This manual is not intended to replace your company's de-energizing or lockout/tagout procedure required by OSHA, but merely to provide general guidance.

The term "lockout," as used in this manual, means placing a lockout device on any and all energy sources to ensure that the energy isolating device and the equipment being controlled cannot be re-energized or operated until the lockout device is removed. The photos on the next page show where the electrical disconnects are located for this machine.



- Energy sources include electrical, mechanical, hydraulic, pneumatic, chemical, thermal, or other energy.
- In the case of electrical energy sources, the main power and control power to the machinery must be turned off and physically locked in the "off" position.
- A lockout device is usually a keyed padlock.
- If more than one person is working in a restricted zone, use a group lockout device that will allow each person to use a lock that can be removed only by the person performing the maintenance.

"Tagout" means that a prominent warning is securely fastened to an energy-isolating device to indicate that the equipment shall not be operated.

Electrical Lockout/Tagout Procedures

When Working on a Machine Outside the Machine's Main Electrical Enclosure



If working on the electrical transmission line to the machine, follow the procedure on page xv.

Before performing maintenance on any machine with electrical power, lockout/tagout the machine properly. When working on a machine outside of the machine's main electrical enclosure, not including work on the electrical transmission line to the machine, follow your company's approved lockout/tagout procedures which should include, but are not limited to the steps here.

1. Engage an E-stop on the machine.
2. Turn the disconnect switch handle to the "off" position. See Figure SAFETY-1.

WARNING	
	<p>ELECTROCUTION HAZARD.</p> <p>When the disconnect switch is off, there is still live power within the disconnect switch's enclosure. Always turn off power at the building's power source to the equipment before opening this electrical enclosure!</p>

3. Attach a lock and tag that meet OSHA requirements for lockout/tagout.
4. Restrain or de-energize all pneumatic components, hydraulic components, and other parts that could have live or stored power.

Figure SAFETY-1: Lockout/Tagout on the Main Electrical Enclosure

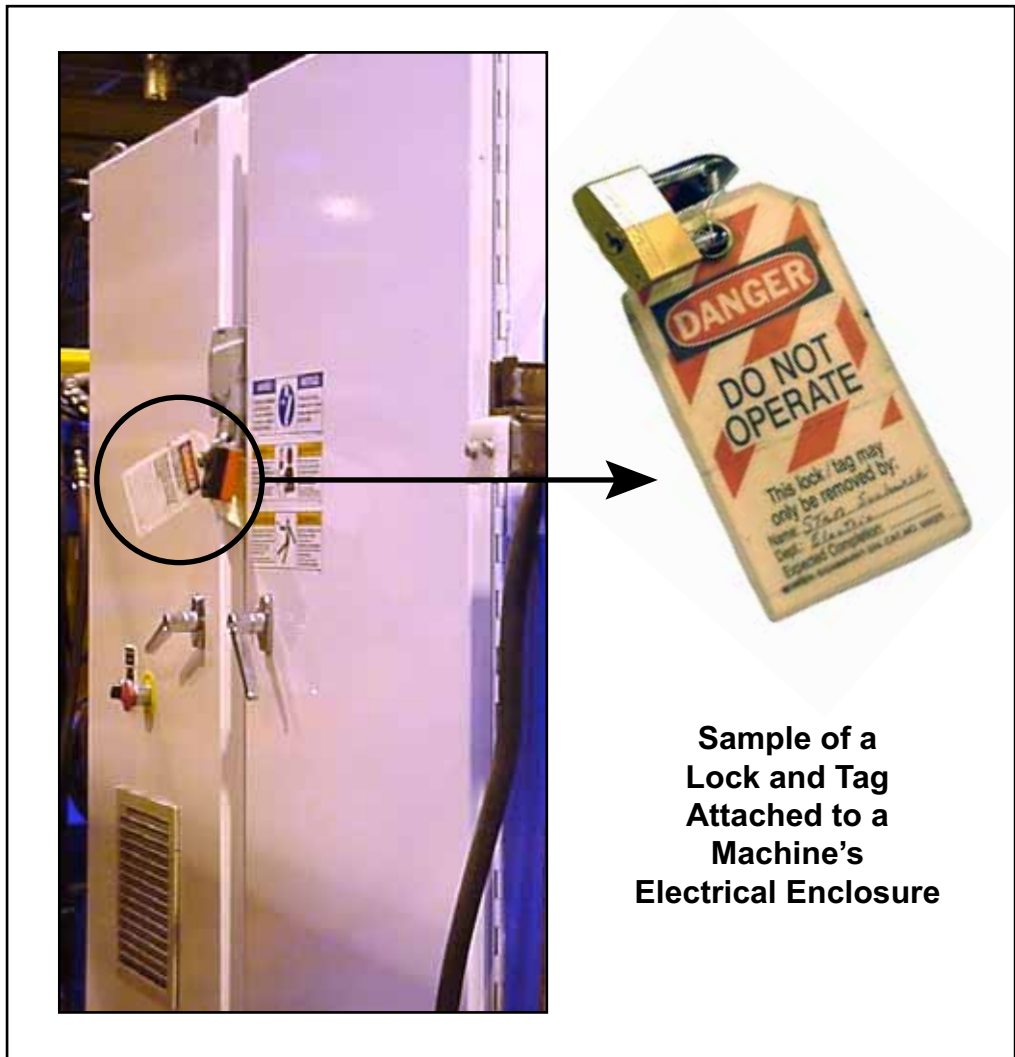

When Working on a Machine Inside the Machine's Main Electrical Enclosure or in the Electrical Transmission Line to the Machine

Before opening the main electrical enclosure, or attempting to repair or replace an electrical transmission line to the machine, lockout/tagout the machine properly. Follow your company's approved lockout/tagout procedures which should include, but are not limited to the steps here.

1. Engage an E-stop on the machine.
2. Shut the power to the machine off at the machine's power source which is usually an electrical service entry panel on the facility wall. One example of a locked-out power source panel is shown in Figure SAFETY-2.
3. Attach a lock and tag that meets OSHA requirements for lockout/tagout.
4. Open the door to the enclosure in which you need access, and using a multimeter, verify that the power is off.

Figure SAFETY-2: Lockout/Tagout on the Power Source Panel



Hydraulic System Lockout/Tagout Procedure

When Lockout/Tagout is Not Required

If working on components other than the hydraulic system, but that requires you to be near the vicinity of movable hydraulic components, you must, at a minimum, physically restrain the hydraulic components from moving. If this is not possible, lockout/tagout the entire hydraulic system.

When Lockout/Tagout is Required

Before attempting repair or performing maintenance on a hydraulic line or component, lockout/tagout the machine properly. Follow your company's approved lockout/tagout procedures.

Troubleshooting With an Energized Machine

Only a qualified electrician, using the personal protective equipment and following the procedures recommended in NFPA 70E should ever attempt service or repair of or near an energized area or component of the machine.

Whenever maintenance is performed while the equipment is electrically energized, there is a potential electric arc flash hazard. Refer to NFPA 70E for the personal protective equipment required when working with electrically energized components. Pneumatic and hydraulic components may move unexpectedly if not de-energized. Physically restrain any components capable of movement when working on or near those components.

Restricted Zone

DANGER	
	<p>Stay out of the restricted zone when equipment is in use. Serious injury or death may result if personnel are in the restricted zone.</p>

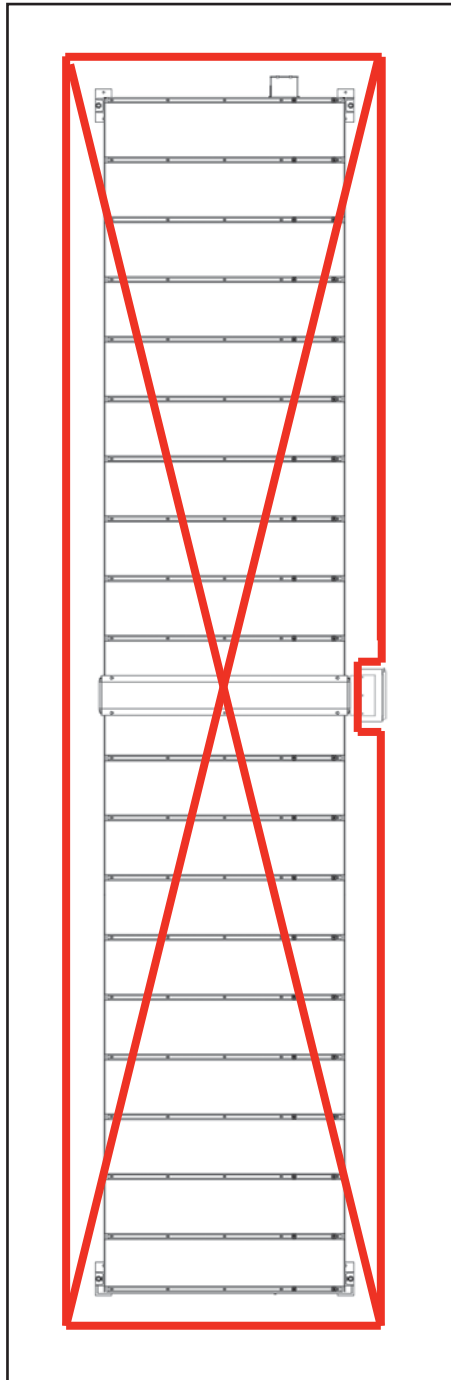

Safety Test

WARNING	
	<p>CRUSH HAZARD.</p> <p>Perform the safety tests described before operating the equipment at the initial startup, after performing any maintenance, and in accordance with the maintenance schedule.</p>

The test procedure **MUST** be performed by qualified personnel at startup and after ANY maintenance, adjustment, or modification. Testing ensures that the safety devices are working correctly.

1. Push the E-stop button on the operator control panel.
2. Ensure that the E-stop stops the pressing action of the platen. It is normal for the gantry to coast a few inches.
3. Reset the E-stop.
4. If you have a machine with dual controls, repeat steps 1 through 3 to test the E-stop on the other operator control panel.

Seguridad (Español)

**Sea cuidadoso.
Protéjase.**



Indicadores de seguridad

Los siguientes símbolos de alerta de seguridad y palabras de advertencia se utilizan a lo largo de este documento para indicar riesgos de seguridad. Preste suma atención cuando los vea. Cada símbolo o palabra indica un nivel de gravedad diferente.

El no cumplimiento de las instrucciones que acompañan a cada símbolo de alerta de seguridad puede producir daños a la propiedad, lesiones personales e incluso la muerte. El personal debe seguir todos los procedimientos y prácticas de seguridad establecidos para asegurar el uso más seguro posible de este equipo. No obstante, en ningún caso este documento reemplaza el sentido común. El personal debe asegurarse de que el entorno de trabajo sea seguro y esté libre de distracciones.



PELIGRO

Indica una situación de riesgo inminente que, si no se evita, pudiera producir la muerte o lesiones graves.



ADVERTENCIA

Indica una situación potencialmente peligrosa que, si no se evita, puede producir la muerte o lesiones graves.



PRECAUCIÓN

Cuando la PRECAUCIÓN se utiliza **con** el símbolo de alerta de seguridad aquí ilustrado, indica una situación potencialmente peligrosa que, si no se evita, puede producir lesiones menores o moderadas.

Cuando PRECAUCIÓN se utiliza **sin** el símbolo de alerta de seguridad aquí ilustrado, indica una situación potencialmente peligrosa que podría producir daños al equipo.

AVISO

AVISO

Llama la atención a información importante para entender la operación que se desea realizar.

AMBIENTAL

AMBIENTAL

Se aplica a condiciones que pueden afectar el entorno pero que no tienen un efecto inmediato o directo sobre el personal o el equipo.

Reglas de seguridad

Debido a la imposibilidad de anticipar todas las circunstancias que podrían constituir un riesgo, la información de seguridad suministrada en este manual del equipo y sobre la máquina no es exhaustiva. Si se utiliza o realiza el mantenimiento de esta máquina utilizando un procedimiento no recomendado específicamente por el fabricante, el procedimiento deberá ser aprobado por un ingeniero profesional para asegurarse de que no afecte la seguridad del equipo. ¡Manéjese! siempre con suma precaución y sentido común!

Conozca su equipo

- Lea este manual en su totalidad antes de utilizar o mantener el equipo. No utilice esta máquina a menos que esté perfectamente familiarizado con los controles, los dispositivos de seguridad, los frenos de emergencia y los procedimientos operativos que se describen en este manual.
- Lea y siga todas las notas de seguridad. El no cumplimiento de estas instrucciones podría producir pérdidas económicas, daños a la propiedad y lesiones personales, incluida la muerte.
- Refiérase a las pautas de bloqueo/etiquetado proporcionadas en las siguientes páginas para realizar el mantenimiento y solucionar problemas de este equipo en forma segura.
- Observe y cumpla con todas las etiquetas de seguridad. Cambie las etiquetas gastadas inmediatamente.
- Utilice este equipo únicamente para el propósito que se describe en este manual.
- Sólo personal calificado debe intentar utilizar o realizar el mantenimiento de este equipo. Por "personal calificado" se entiende:

*...una persona o personas que, por el hecho de poseer un título o certificado de capacitación profesional reconocido o que, por sus amplios conocimientos o experiencia, han demostrado con éxito estar capacitados para resolver problemas relacionados con el tema y el trabajo en cuestión
—ANSI B30.2-1983*

...una persona que posee habilidades y conocimientos relacionados con la construcción y uso de equipos e instalaciones eléctricas y que ha recibido capacitación en seguridad sobre los riesgos posibles—NEC 2002 Handbook

Seguridad personal

- Use siempre anteojos de seguridad y protección auditiva en un entorno industrial.
- Utilice una máscara protectora cuando trabaje cerca de aserrín.
- Utilice ropa adecuada y equipo de protección personal apropiado (por ejemplo, anteojos de seguridad y protección auditiva.) No use ropa suelta ni joyas. Si tiene el cabello largo, áteselo para atrás.
- Proceda con precaución cuando levante piezas o materiales pesados.

Instalación del equipo

- Siga las instrucciones de instalación al pie de la letra.

Procedimientos de Bloqueo/Etiquetado

- Antes de realizar el mantenimiento de los sistemas neumáticos o hidráulicos, purgue las líneas para eliminar la presión.
- Bloquee y etiquete todos los sistemas energizados antes de realizar tareas de mantenimiento en ellos. Refiérase a la sección *Pautas de bloqueo/etiquetado* en la página xxiv.

Cómo mantener un entorno seguro

- Mantenga alejados a los niños. Todos los visitantes deben mantenerse a una distancia segura del área de trabajo. Los riesgos pueden no ser evidentes a las personas no familiarizadas con la máquina.
- Mantenga las áreas de trabajo bien iluminadas.
- Mantenga el área de trabajo limpia y libre de cualquier riesgo de tropiezo o resbalamiento.
- No utilice el equipo en lugares húmedos o mojados y no lo exponga a la lluvia o a la nieve.

Uso y mantenimiento del equipo

- Asegúrese de que no haya personas, herramientas y objetos extraños en las zonas restringidas antes de utilizar este equipo. Las zonas restringidas se indican en la página xxx.
- Realice pruebas de seguridad para verificar que todos los frenos de emergencia funcionen adecuadamente antes de utilizar el equipo por primera vez, después de realizar cualquier tarea de mantenimiento y según la frecuencia de mantenimiento establecida.
- En caso de que la máquina no funcione correctamente, deténgala inmediatamente utilizando un freno de emergencia e informe el problema a un supervisor.
- No deje nunca la máquina encendida si no está junto a ella. ¡Apáguela!. No abandone la máquina hasta que todas las piezas se detengan completamente y hasta que se haya apagado la alimentación eléctrica.
- Verifique periódicamente que no haya piezas gastadas o dañadas. Repárelas o cámbielas inmediatamente.
- Mantenga los sistemas hidráulicos, neumáticos y eléctricos en buen funcionamiento en todo momento. Repare las fugas y las conexiones sueltas inmediatamente. No exceda nunca la presión ni potencia eléctrica recomendadas.

- Verifique que todos los dispositivos de seguridad estén en buen funcionamiento al comienzo de cada turno. Todos los dispositivos protectores y de seguridad deben estar en su lugar antes y durante el uso de la máquina. No desconecte ni evite nunca ningún dispositivo de seguridad ni interbloqueo eléctrico.
- Inspeccione periódicamente la calidad del producto terminado.

Seguridad eléctrica

- No utilice líquidos en el interior de los gabinetes eléctricos.
- Cuando utilice disolventes sobre o alrededor de la máquina, desconecte la alimentación para eliminar las probabilidades de chispas, que pueden producir una explosión o incendio. Use un respirador aprobado para el uso con disolventes. Use ropa protectora, guantes y anteojos de seguridad.

Bloqueo/Etiquetado

Pautas de bloqueo/etiquetado

Deben cumplir con todas las pautas de bloqueo/etiquetado conforme a la norma OSHA 29 CFR 1910.147. El programa de control de energía de la compañía debe incluir un procedimiento específico. El objetivo de este manual no es reemplazar el procedimiento de desenergización o bloqueo/etiquetado requerido por la OSHA, sino proporcionar pautas orientativas generales.

El término "bloqueo", según se utiliza en este manual, se refiere a la colocación de un dispositivo de bloqueo en las fuentes de energía para asegurar que el dispositivo aislador de energía y el equipo controlado por éste no puedan reenergizarse o utilizarse hasta que se retire dicho dispositivo.

Las fotos de la página siguiente muestran los lugares en los que se encuentran los interruptores de desconexión eléctrica de esta máquina.

- Las fuentes de energía incluyen energía eléctrica, mecánica, hidráulica, neumática, química, térmica y otras.
- En el caso de fuentes de energía eléctrica, la alimentación principal y la alimentación de control a la maquinaria deben apagarse y bloquearse físicamente en la posición "off" (apagado).
- Por lo general, como dispositivo de bloqueo se utiliza un candado con llave.
- Si hay más de una persona trabajando en una zona restringida, utilice un dispositivo de bloqueo grupal que permita a cada persona utilizar un candado que sólo pueda ser retirado por la persona que realiza el mantenimiento.

"Etiquetado" significa que debe colocarse una advertencia fácil de ver en un dispositivo aislador de energía que indique que el equipo no debe utilizarse.



Procedimientos de bloqueo/etiquetado eléctricos

Cuando trabaja en una máquina fuera del gabinete eléctrico principal de la máquina



Si trabaja en la línea de transmisión eléctrica a la máquina, siga el procedimiento de la página xxvii.

Antes de realizar el mantenimiento de cualquier máquina con alimentación eléctrica, bloquee y etiquete la máquina de forma adecuada. Cuando trabaje en una máquina fuera del gabinete eléctrico principal de la máquina, salvo en el caso de trabajos en la línea de transmisión eléctrica a la máquina, siga los procedimientos de bloqueo/etiquetado aprobados por la compañía, los cuales deberían incluir, entre otros, los pasos aquí indicados.

1. Coloque un freno de emergencia sobre la máquina.
2. Coloque el mango del interruptor con fusibles en la posición "apagado/apagada". Vea la figura 2-1.

	<p>RIESGO DE ELECTROCUCIÓN.</p> <p>Cuando el interruptor con fusibles está apagado, sigue habiendo energía dentro del gabinete del interruptor. ¡Apague siempre la alimentación en la fuente de alimentación del edificio antes de abrir este gabinete eléctrico!</p>

3. Coloque un candado y una etiqueta que cumplan con los requisitos de bloqueo/etiquetado de la OSHA.
4. Trabe o desenergice todos los componente neumáticos, componentes hidráulicos y otras piezas que tengan alimentación directa o almacenada.

Figura SEGURIDAD-1: Bloqueo/etiquetado en el gabinete eléctrico principal

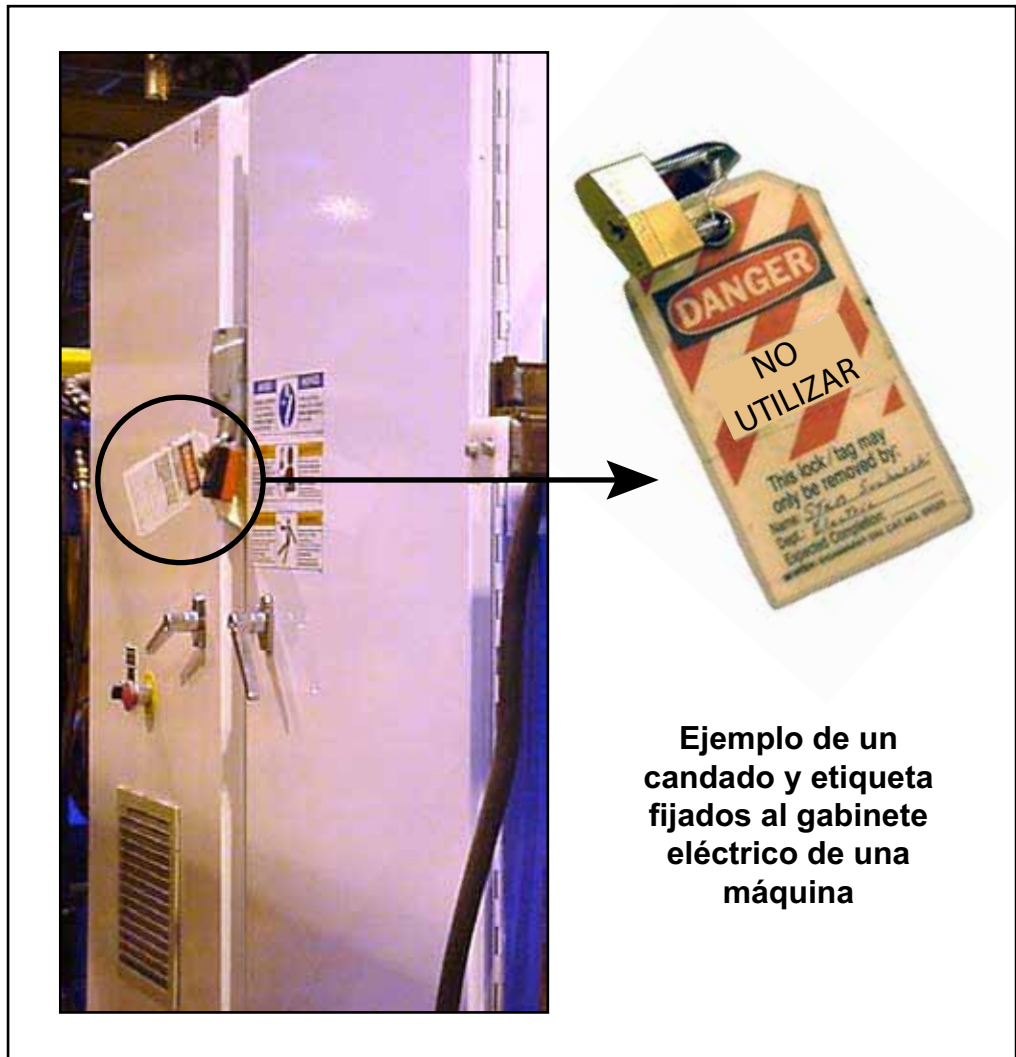

Cuando trabaje en una máquina dentro del gabinete eléctrico principal de la máquina o en la línea de transmisión eléctrica a la máquina

Antes de abrir el gabinete eléctrico principal o intentar reparar o reemplazar una línea de transmisión eléctrica a la máquina, bloquee y etiqueta la máquina en forma adecuada. Siga los procedimientos de bloqueo/etiquetado aprobados por la compañía, los cuales deberían incluir, entre otros, los pasos aquí indicados.

1. Coloque un freno de emergencia sobre la máquina.
2. Apague la alimentación a la máquina en la fuente de alimentación, que, por lo general, es un panel de entrada de suministro eléctrico que se encuentra en una pared de las instalaciones. En la figura 2-2 se muestra un ejemplo de panel de fuente de alimentación bloqueado.
3. Coloque un candado y una etiqueta que cumplan con los requisitos de bloqueo/etiquetado de la OSHA.
4. Abra la puerta del gabinete al que necesita acceder y usando un multímetro verifique que la alimentación esté apagada.

Figura SEGURIDAD-2: Bloqueo/Etiquetado del panel de fuente de alimentación



Procedimiento de bloqueo/etiquetado de sistema hidráulico

Cuando no se requiere bloqueo/etiquetado

Si trabaja con componentes que no son del sistema hidráulico pero que requieren su presencia en la proximidad de componentes hidráulicos móviles, debe, como mínimo, trabar físicamente estos componentes para que no se muevan. Si no es posible, bloquee/etiquete todo el sistema hidráulico.

Cuando se requiere bloqueo/etiquetado

Antes de intentar reparar o realizar el mantenimiento de una línea o componente hidráulico, bloquee y etiquete la máquina en forma apropiada. Siga los procedimientos de bloqueo/etiquetado aprobados por la compañía.

Solución de problemas con una máquina energizada

Sólo un electricista calificado que utilice el equipo de protección personal y siga los procedimientos recomendados en la norma NFPA 70E debe intentar realizar tareas de reparación o mantenimiento en un área o componente energizados de la máquina o en su proximidad.

Cada vez que se realizan tareas de mantenimiento mientras el equipo está eléctricamente energizado, existe un riesgo potencial de formación de un arco eléctrico. Consulte en la norma NFPA 70E el equipo de protección personal requerido para trabajar con componentes eléctricamente energizados. Los componentes neumáticos e hidráulicos pueden moverse de manera imprevista si no se desenergizan. Trabe físicamente cualquier componente que pueda moverse cuando deba trabajar en ellos o en su proximidad.

Zonas restringida

	<p>Manténgase afuera de la zona restringida cuando el equipo esté en uso. Pueden producirse lesiones graves o incluso la muerte si el personal está en la zona restringida.</p>

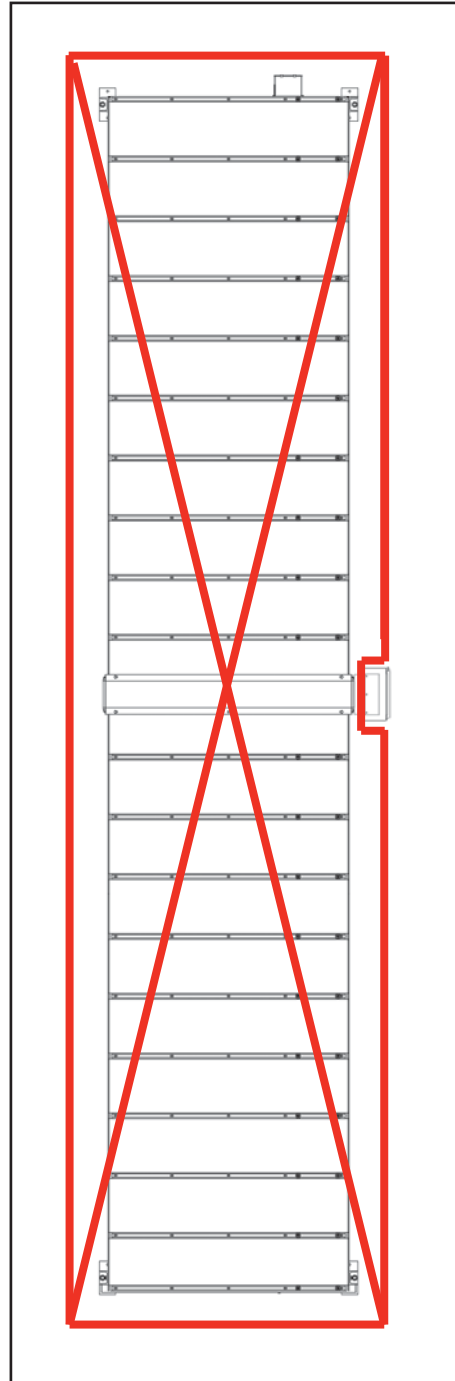

Prueba de seguridad

	<p>RIESGO DE APLASTAMIENTO.</p> <p>Realice las pruebas de seguridad descritas antes de utilizar el equipo al ponerlo en marcha por primera vez, después de realizar cualquier tarea de mantenimiento y conforme al plan de mantenimiento.</p>

El procedimiento de prueba DEBE ser realizado por personal calificado al poner en marcha el equipo y después de realizar CUALQUIER tarea de mantenimiento, ajuste o modificación. La prueba asegura que los dispositivos de seguridad estén funcionando correctamente.

1. Pulse el botón E-stop (freno de emergencia) en el panel de control del operador.
2. Asegúrese de que el freno de emergencia detenga la acción de prensado del plato. Es normal que el pórtico se mueva algunas pulgadas.
3. Vuelva a conectar el freno de emergencia.
4. Si tiene una máquina con controles dobles, repita los pasos del 1 al 3 para probar el freno de emergencia en el otro panel de control del operador.

Purpose of Chapter

This chapter explains how to navigate through the equipment manual and how to contact MiTek.

Introduction to the Manual

WARNING	
	<p>Read this manual completely before using this equipment!</p> <p>Do not operate this machine until you have a thorough understanding of all controls, safety devices, emergency stops, and operating procedures outlined in this manual.</p> <p>All warnings must be read and observed. Failure to do so may result in economic loss, property damage, and/or personal injury.</p> <p>This manual must always be available to personnel operating and maintaining this equipment.</p>

Purpose and Scope of This Equipment Manual

In order for this equipment manual to be useful, it must be kept in a location where operators and maintenance personnel have easy access to it.

This manual addresses the most recent versions of the equipment as of the creation or revision date on the title page. For earlier revisions, contact MiTek Machinery Division Customer Service. The part number is listed on the title page, but the revision you require depends on the date your equipment was manufactured.





This manual can be a valuable training tool.

- The Introduction and *General Information* chapter contains information on truss terminology and provides basic information about the equipment.
- The *Operation* chapter teaches operators how to efficiently operate the machine.
- The *Maintenance* chapter is written specifically for maintenance personnel.
- The appendices provide valuable technical and training information to keep your equipment running.

Navigation

The graphics in Table 1-1 are used throughout the manual to quickly communicate a specific type of information.

Table 1-1: Navigational Tools Used Throughout the Manual

	Explanation
	<p>Important safety note!</p> <p>Indicates that you must lockout/tagout at the disconnect switch located on the equipment using approved methods described in OSHA 29 CFR 1910.147 before continuing with the procedure.</p>
	<p>Indicates tools required before beginning a procedure.</p>
	<p>Gives additional information to the steps or text.</p>
	<p>Refers reader to another section, table, graphic, or drawing for further explanation.</p>

Additional Resources

Supplemental Documentation

In addition to the equipment manual, refer to the manufacturer's documentation provided for certain parts. The supplemental documentation is provided at the time of installation, or it may be found inside an electrical enclosure. Refer to these documents when you need more detailed information on these components than the MiTek manual provides.

Web Site

Visit the MiTek Web site at www.mii.com for up-to-date information on all MiTek equipment. View the latest revision of this manual and all Service Bulletins, or order parts on-line through our *eStore*™.

Contacting MiTek

For technical assistance or to order parts, contact the Machinery Division Customer Service Department using one of the methods listed in Figure 1-1.

Figure 1-1: Contacting MiTek

<p>MiTek Machinery Division Customer Service Department 301 Fountain Lakes Industrial Drive St. Charles, MO 63301</p> <p>Parts Orders (with part number) <i>eStore</i>™ at http://estore.mii.com E-mail: mitekparts@mii.com</p> <p>Web Site www.mii.com/machinery</p> <p>Technical Assistance Phone: 800-523-3380 Fax: 636-328-9218</p>	 The MiTek logo, consisting of the letters 'MII' in a bold, black, sans-serif font with three horizontal blue lines through the 'I's.
--	--

Purpose of Chapter

This chapter provides an overview of the equipment and the means to identify it.

Introduction to the Equipment

Purpose of the Equipment

The *Jack Table* platen press is a fast, accurate, and economical method of pressing jack trusses. It is capable of pressing for all of your jack truss needs, within certain specifications.

Description of the Equipment

The *Jack Table* platen press is a self-contained jack truss pressing machine consisting of a table and gantry head.

Each table is capable of supporting truss material as trusses are assembled. The gantry and platen press nail plates into jack trusses. The *Jack Table* can be constructed in various ways to meet customer needs. Variations include U-channel jigging slots, dual operator controls, 30- or 50-ton hydraulic press, and plastic, wood, or drilled steel table tops.

Figure 2-1 and Figure 2-2 show a *Jack Table*. Refer to the *Maintenance* chapter for more detailed graphics.

Figure 2-1: *Jack Table* Platen Press (U-Channel with 30-Ton Hydraulic Unit Shown)

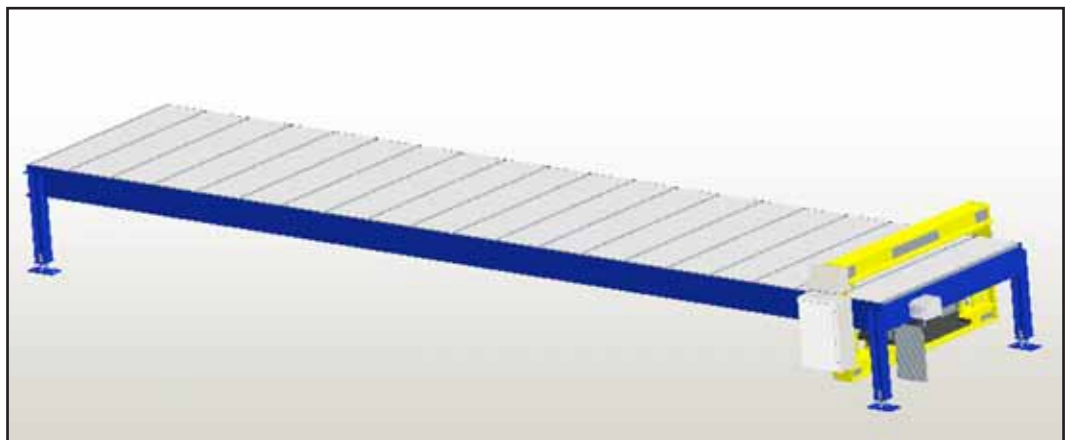
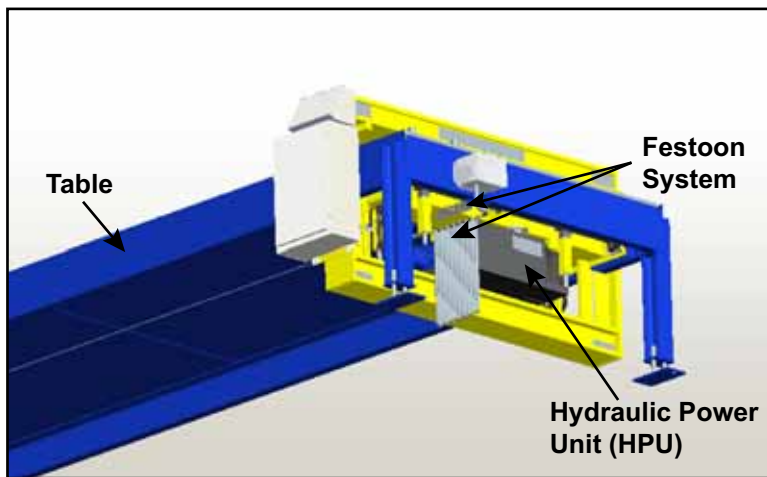
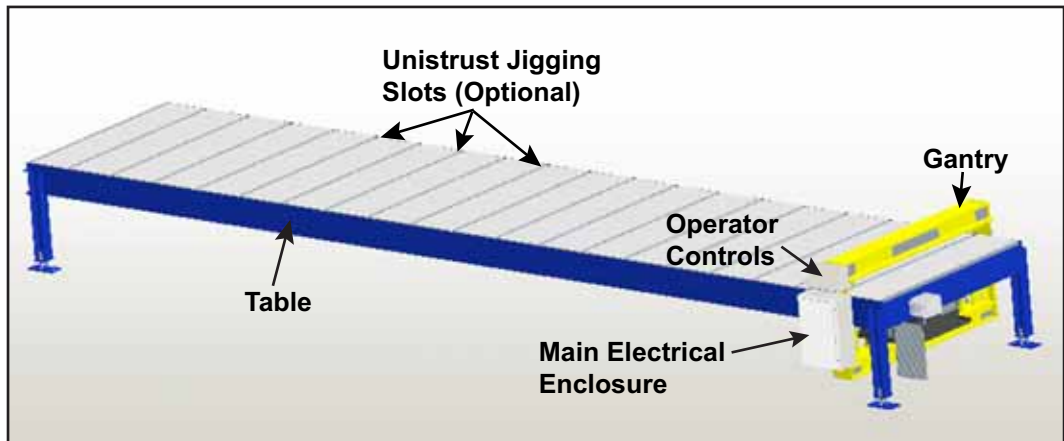

Figure 2-2: Getting to Know Your System (U-Channel with 30-Ton Hydraulic Unit Shown)



Main Components and Optional Equipment

Table 2-1 lists the main components that comprise this system.

Table 2-1: Main Components

	Description	Part #
Table with U-channel	Provides a pressing surface for the truss; available in 20', 25', 30', 35' and 40' lengths and with plastic or wood top	30002-501
Table with solid top	Provides a pressing surface for the truss; available in 20', 25', 30', 35' and 40' lengths and with plastic or wood top	30084-501
Gantry, 30-ton	Presses nail plates into the truss	30001-501-V
Gantry, 50-ton	Presses nail plates into the truss	30086-501-V
Hydraulic system, 30-ton	Provides power to the gantry and platen	30005-501
Hydraulic system, 50-ton	Provides power to the gantry and platen	30096-501

Table 2-2 lists the options available with this system.

Table 2-2: Optional Components and Features

	Description	Part #
Jigging, U-channel	Provides guidelines for easy truss setup	30077-501
Dual operator controls	Allows the gantry to be controlled from either side of the table	90601-603
Hydraulic unit heater	Keeps the hydraulic fluid heated; recommended for cold environments	Consult your MiTek Sales Representative

General Specifications

Table 2-3: General Specifications

General	
Maximum truss height	5'
Maximum truss length	Length of table
Blocking	2" standard, 3" and 4" available
Table length	20', 24', or 30"
Table width	6'
Table top material	3/4" plywood and 1" plastic, drilled steel
U-channel spacing	8", 12", or 18" on center
Platen size - pressing area	12" wide, 66" wide
Hydraulics	
Reservoir capacity	7 gal
Operating pressure for pressing, 30-ton	2500 psi
Operating pressure for pressing, 50-ton	2700 psi
Operating pressure for motor torque, 30-ton	750 psi
Operating pressure for motor torque, 50-ton	1200 psi
HPU motor horsepower	7.5 hp
Dimensions of System Components	
See Table 3-2	
Weight of System Components	
See Table 3-4	

Truss Terminology

Table 2-4: Truss Terminology

Length Types	Height Types	
Overall length	H1	Board height
Centerline length	H2	Centerline height
Top length	H3	Centerline height
Bottom length	H4	Centerline height

Figure 2-3: Terminology Diagram

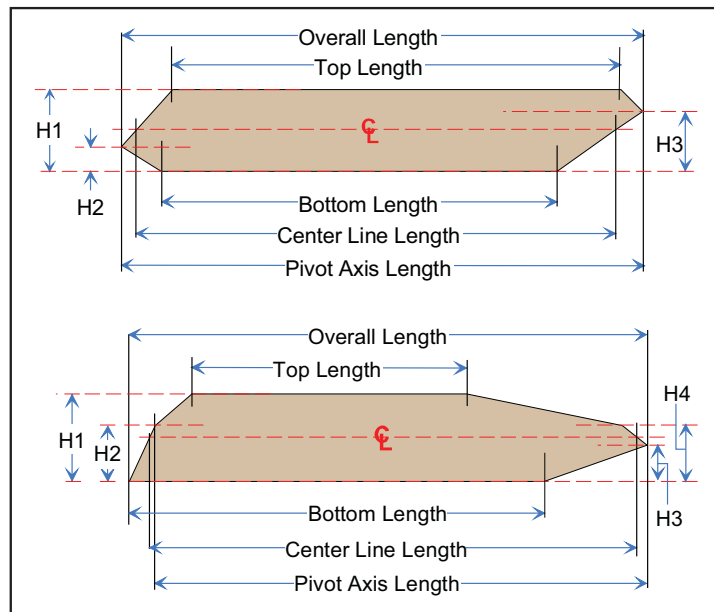
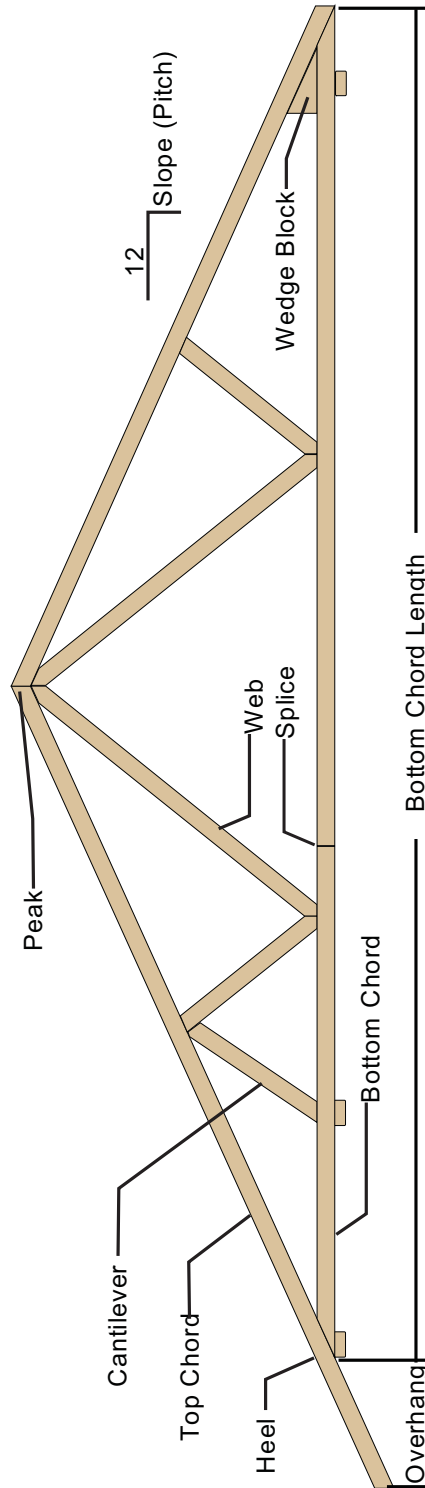

Figure 2-4: Parts of a Truss



Purpose of Chapter

This chapter covers what you must consider or complete before this equipment can be installed.

MiTek's Responsibilities

Prior to Installation

MiTek will provide the following items and information prior to the installation date:

1. A Prior to Installation package that:
 - Outlines this chapter and requests your signature of agreement.
 - Gives dates to expect shipment, delivery, and installation.
 - Explains the number of people required to help with installation.
 - Provides guidelines on providing an electrician, welder, and other specialists.
 - Describes payment information.
2. A layout showing how you have indicated that you wish the equipment to be arranged within your building.

During Installation

For an additional fee, a MiTek Customer Service Technician (CST) can be present to oversee the installation of your equipment.

Customer Responsibilities

Before the installation of your equipment, the items and procedures in this chapter must be arranged, purchased, or assembled. Table 3-1 provides an overview of these items. Each topic listed in the table is explained in detail in the text following the table.

Installation of this machine is not included in the purchase price.

Table 3-1: Summary of Customer Responsibilities

Space Requirements	This equipment requires enough space to allow for the machine dimensions listed in Table 3-2, plus additional working space for operation and maintenance. Space should have adequate lighting.
Location Requirements	Reinforced concrete, a minimum of 6 in. thick 3,500 psi, is required to support the weight of the <i>Jack Table</i> . The equipment discussed in this manual must be used in dry conditions under a roofed area according to Type 1 electrical enclosure requirements.
Electrical Requirements	The standard electrical requirements are shown in Table 3-3. Contact your MiTek representative immediately if custom power specifications need to be accommodated.
Hydraulic System Requirements	Hydraulic fluid that meets the requirements in Table 7-1 must be on-hand during the installation process.
Shipping Requirements	See Table 3-4 for shipping weights.
Customer-Supplied Items	The customer is responsible for having the supplies listed in Table 3-5 available at the time of installation.

Space Requirements

Refer to your individual layout when planning your space allocation. Refer to Table 3-2 for approximate dimensions. MiTek can provide help with plant layout and space utilization upon request.

Figure 3-1: Sample of a Layout for a Complete System

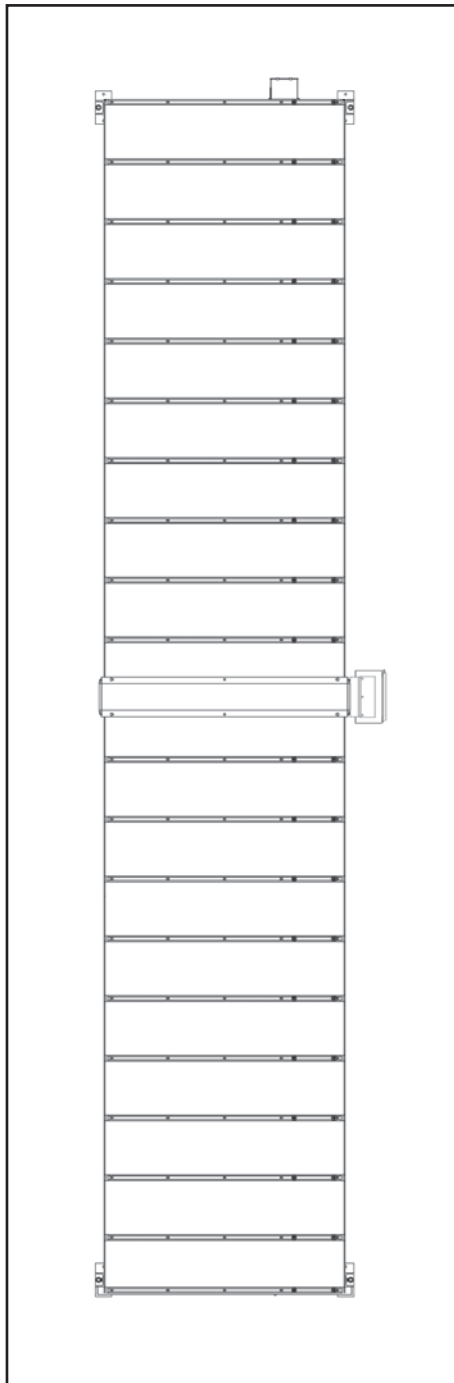

Space for the Equipment

It is the customer’s responsibility to provide adequate space for the installation, operation, and protection of the equipment. The physical dimensions of the equipment are shown in Table 3-2. Additional space is required for operation, maintenance, and optional equipment.

Table 3-2: Approximate Equipment Dimensions

	Width - Single Control	Width - Dual Control	Length
20' Table	86-7/8" (7' 2-7/8")	93-5/8" (7' 9-5/8")	240" (20')
24' Table	86-7/8" (7' 2-7/8")	93-5/8" (7' 9-5/8")	288" (24')
30' Table	86-7/8" (7' 2-7/8")	93-5/8" (7' 9-5/8")	360" (30')

Space for Operation and Maintenance

Additional space must be allocated for operation and maintenance. Space should allow for safe operation, freedom of movement, storage space, and free flow of raw and finished materials.

Determining the Space Needed for Your System

Refer to your individual layout to determine the space needed for your system.

Location Requirements

Floor Structure

A level and structurally sound concrete slab must be provided for the installation of the equipment. This slab should be designed and installed in accordance with local building code requirements. Reinforced concrete should be a minimum of 6 in. thick. Three thousand five hundred (3,500) psi concrete is recommended. Refer to your layout drawing.

Environment

The equipment must be used in dry conditions under a roofed area according to Type 1 electrical enclosure requirements.

Lighting should be adequate for safe operation and maintenance.

Electrical Requirements

WARNING	
	<p>ELECTRICAL HAZARD!</p> <p>All electrical work must be performed by a licensed electrician.</p> <p>Follow approved lockout/tagout procedures (OSHA 29 CFR 1910.147).</p>

The standard electrical requirements are shown in Table 3-3. Each machine can be adapted for use with any of the incoming voltages listed.

The power supply must have a fused disconnect switch, separate from the disconnect switch on the machine. The power supply line must reach the disconnect enclosure on the machine.

You must indicate what voltage is available at the machine's proposed location when placing the order. This information must be correct. Depending on the voltage available, revisions to the electrical system or a transformer may be necessary.

Table 3-3: Minimum Electrical Requirements for This Equipment

Voltage	208/230/380/415/460/575 VAC
FLA Plus Control Amperage	22.2/20/1/12.6/11.4/10/8.07 amps
Equipment Disconnect Protection	30 amps
Cycles (Frequency)	60/60/50/50/60/60 Hz
Phases	3

Hydraulic System Requirements



10 gallons of hydraulic fluid must be available for the initial charge of the machine prior to startup.

WARNING	
	<p>HIGH PRESSURE HAZARD.</p> <p>Compressed air and hydraulic lines should be installed only by qualified personnel familiar with all governing regulations. Failure to use proper materials and installation practices can result in ruptured lines leading to personal injury, equipment damage, and equipment failure.</p>

You must have 10 gallons of hydraulic fluid on-site during the installation of this equipment. It can not operate without the proper hydraulic fluid.

Refer to Table 7-1 on page 41 in the *Maintenance* chapter for hydraulic fluid specifications.

Shipping Information

When the equipment arrives, you must have the proper transport and lifting equipment available to remove it from the truck and place it in your facility. Table 3-4 lists the weight of the typical systems.

DANGER	
	<p>Transport and lifting equipment such as forklifts and cranes must be designed and rated for the load and application. The weight of each major component is given in Table 3-4.</p> <p>Inadequate transport equipment may result in property damage, personal injury, or death.</p>

Table 3-4: Shipping Information

Contents of Shipment	Approximate Weight
<i>Jack Table, 20'</i>	6,500 lb
<i>Jack Table, 24'</i>	7,500 lb
<i>Jack Table, 30'</i>	10,000 lb

Customer-Supplied Parts

The customer must supply the parts shown in Table 3-5. Some must be installed before installation of the equipment and some must be available for use at the time of installation.

Table 3-5: Customer-Supplied Parts

When Needed	Description
Electrical Equipment	All electrical requirements to provide power to the disconnect enclosure on the <i>Jack Table</i> are the customer's responsibility
Transport Equipment	Two heavy-duty forklifts or truck wreckers are required to move the equipment during unloading and placement of the machine. All transport and lifting equipment must meet the requirements given in the <i>Shipping Information</i> section
Tools That May Need to be Rented	Transit with measuring stick Industrial hammer-drill Hydraulic jack
General Tools	Standard wrench set 6' level

Training Provided

If MiTek is overseeing the installation of your equipment, the MiTek representative trains your operators and maintenance personnel on the equipment's proper operation and maintenance. The representative explains the warranty policy, gives an overview of the equipment manual, and requests your signature that the manual was received.

If a MiTek representative is not required to be present, it is your responsibility to ensure all necessary personnel read the Equipment Manual and address all guidelines and safety instructions given.

Purpose of Chapter

This chapter describes the entire installation process in detail. The instructions assume that the prior-to-installation requirements are satisfied.

Responsibilities During Installation

Upon request, MiTek can provide installation supervision to ensure that the system is installed properly and operates correctly. We will also provide operating and maintenance training at the time the equipment is installed. The customer is responsible for providing all labor and equipment needed to complete the installation. These requirements are explained in the *Prior to Installation* chapter.

This equipment generally does not need a MiTek representative to be present for the installation.



All customer responsibilities before and during installation are described in the *Prior to Installation* chapter!

Delivery

Checking for Damage

All shipments from MiTek are covered with tarps. When your shipment arrives, check to ensure that the tarps are in place. Displaced tarps may indicate a potential problem.

After removing the tarps, inspect the shipment for water/moisture, debris, and damage. Report any findings as required by the transport company. Document any findings by taking photographs or a video. Note any and all damage to the equipment on the bill of lading to ensure proper documentation for insurance claims. Without this note, any damage in transit is the responsibility of the customer to repair.

Notify MiTek Machinery Division Customer Service of any unacceptable findings discovered during the receipt inspection. Although your findings may not appear to be a problem, they may cause premature failure of components, poor performance, or erratic performance.

Unloading



Refer to...

Table 3-4 on page 15 for the weight of each component

Refer to the *Prior to Installation* chapter for information regarding preparing for the delivery.

Even if a MiTek representative is present, it is the customer’s responsibility to provide equipment and labor for unloading, placement, and wiring of the equipment. Two heavy-duty forklifts or truck wreckers are required to move the equipment during unloading and placement of the machine. The lifting equipment must be rated appropriately for the weights shown in Table 3-4 on page 15.

Exercise extreme caution to avoid damage or misalignment during unloading. Do not apply pressure on any moving parts or fittings. Figure 4-1 shows how to lift and move the equipment safely. If lifting from the side instead of the ends, you must use fork extensions.

WARNING	
	<p>CRUSH HAZARD.</p> <p>Failure to lift the equipment in the prescribed manner may cause serious injury, including death, or equipment damage.</p> <p>Personnel not involved in the off-loading from the truck shall remain clear of the area.</p> <p>Transport and lifting equipment such as forklifts and cranes must be designed and rated for the load and application.</p>

Figure 4-1: Lift Points



Unpacking

After successful unloading, remove the protective crating material from the pallets. Detach and set aside all loose parts. Move the equipment to the desired location using a forklift or crane appropriate to the weight of each unit. Lift the equipment to remove the pallet, and gently place each unit in its new location.

Equipment Layout

Each component must be located in specific locations. Refer to your own layout during installation. Your MiTek representative will provide your layout to you before the equipment is installed.

Installing the *Jack Table*

Placing the Table

1. Mark the location of the each end of the table.
2. Put the table in place per your specific layout.
3. Double-check the factors below:
 - a) Adequate space between walls and the equipment for maintenance purposes.
 - b) Safety regulations requiring a minimum of 3 ft of clear space in front of electrical enclosures.

Anchoring the Table

1. Anchor the table.
 - a) Locate the hardware.
 - Concrete anchors (1/2 in. x 4-1/2 in. are supplied).
 - Additional boxes can be ordered if needed.
 - b) Install the concrete anchors.

- 1) Using an industrial hammer drill and a 1/2-in. drill bit, drill a hole at least 6 in. deep through the holes in the table anchor plates. For best results, drill the hole completely through the concrete pad.



If you do not drill completely through the concrete, you must vacuum out the concrete dust before proceeding with the next steps.

- 2) Place the anchor in the hole, flanged end first.
 - 3) Use a mallet or hammer to pound the anchor into the hole.
2. Repeat this procedure until the table is anchored at all four corners. Turn the nut to tighten.

Leveling the Table

1. Using a 6-ft level, check the level of the table in both directions.
2. Change the level by adjusting the 1-in. nuts on the table leg bolts.
3. Continue checking and adjusting the leg until the table is perfectly level.

Hydraulic System

Hydraulic Fluid

See Table 7-1 on page 41 in the *Maintenance* chapter for hydraulic fluid specifications. The indicated amount of hydraulic fluid must be available during installation.

CAUTION

**Add hydraulic fluid before turning on the system.
The equipment is shipped with the reservoir empty.**

Connecting the Hoses

All hydraulic hoses are connected before shipping. Check hoses for tightness and reconnect any loose hoses.

Electrical Connections to the HPU

The HPU is connected to the machine's main electrical enclosure by a festoon cable system. The festoon cable is connected to the gantry and to the main electrical enclosure before the machine is shipped. Check electrical connections for tightness and tighten or reconnect as necessary.

Electrical System

DANGER	
	<p>ELECTRICAL HAZARD!</p> <p>All electrical work shall be done by a licensed electrician and shall conform to all regulating codes. In the event that information in this manual conflicts with local code requirements, please contact MiTek Machinery Division Customer Service.</p> <p>Do not turn on electrical power until you have read the startup procedure. Follow approved lockout and tagout procedures in accordance with OSHA 19 CFR 1910.147.</p>

Checking Existing Wiring

Heavy gauge wire can work loose during shipping and handling. Before power is connected to the machine, conduct a pull test on all pre-wired connections inside the electrical enclosures.

Connecting Power to the Equipment

All electrical work is the customer's responsibility and must be performed by a licensed electrician. The machine design addresses electrical components starting with the disconnect enclosure. Installation and maintenance of all electrical requirements up to the disconnect enclosure are the responsibility of the customer. Your MiTek representative can provide guidance regarding when the electrical will need to be available during the installation.

The disconnect on the main electrical enclosure is shown in Figure 6-3 on page 27.

Installation Checklist

- Check the shipment for damage
- Unload the equipment
- Unpack the equipment
- Review the equipment layout
- Place the table
- Anchor the table
- Level the table
- Check hydraulic hose connections
- Check electrical connections to the HPU
- Check the remaining wiring
- Connect power to the machine's main electrical enclosure

WARNING	
	<p>ELECTROCUTION, HIGH PRESSURE, CRUSH, CUT, AND CHEMICAL HAZARDS!</p> <p>Do not attempt to start the system without a MiTek representative present!</p> <p>Serious injury and/or equipment damage may result.</p>

Purpose of Chapter

This chapter describes the procedures required before operating your equipment.



The equipment is shipped with the hydraulic fluid reservoir empty. Add fluid before turning equipment on!

Preparing the Hydraulic System

Fill the hydraulic reservoir with hydraulic fluid that matches the specification listed in Table 7-1 on page 41. Ensure that you have the required amount of hydraulic fluid prior to planning the startup. The reservoir should be filled to within 2 in. from the top. Watch the sight gauge on the reservoir to determine the fill level. Refer to the procedure on page 49 of the *Maintenance* chapter.

CAUTION	
	<p>SLIP HAZARD.</p> <p>Do not overfill. Clean up any spillage immediately to avoid injury.</p>

Checking Motor Rotation

Check the motor rotation of the HPU motor to ensure it is rotating in the same direction as the arrow on its housing. If the motor is rotating in the wrong direction, lockout/tagout the machine and switch any two of the lead wires located on the motor's junction box.

Safety Tests

Perform the safety tests beginning on page xviii or page xxxi before operating the equipment at the initial startup, after performing any maintenance, and in accordance with the maintenance schedule.

Purpose of Chapter

This chapter describes the operating mechanisms on this equipment and the procedure to operate it in most circumstances.

Before You Begin

Safety Operating Notes

WARNING	
	<p>ELECTROCUTION, HIGH PRESSURE, CRUSH, CUT, AND CHEMICAL HAZARDS!</p> <p>Read this section AND the safety section in the preliminary pages before operating or maintaining this equipment.</p> <p>Do not operate this machine until you have a thorough understanding of all controls, safety devices, E-stops, and operating procedures outlined in this manual.</p> <p>Read and observe all warnings. Failure to do so may result in economic loss, property damage, and/or personal injury.</p> <p>This manual must always be available to personnel operating and maintaining this equipment.</p>

WARNING	
	<p>CRUSH AND CUT HAZARD.</p> <p>Before turning on the equipment, make sure that all personnel and equipment are out of the restricted zone (see page xvii or page xxx).</p>

Stopping the Machine

Emergency stops (E-stops) immediately cease electrical power transmitting to the control circuit. Utilize the E-stop on this machine to cease power, which will stop the pressing action of the machine. The gantry will coast a few inches after an E-stop is pressed.

Do not use the E-stop as a standard stopping method during the operation procedure. Overuse may cause certain components to wear faster.

The E-stop is located on the operator control station. Machines with the dual-control option will have two E-stops.

Figure 6-1: E-Stop Locations



E-Stop Pushbutton

A typical E-stop pushbutton is shown in Figure 6-2. To activate the pushbutton, push the entire red button in. To release the pushbutton E-stop, pull straight up on the pushbutton. It will return to its extended position. Once the START button is depressed the machine will operate again.

Figure 6-2: E-Stop Pushbutton



Disconnect Switch

Figure 6-3 shows the location of the disconnect switch that controls the power supplied from that switch to the rest of the machine. Turning the disconnect handle to the ON position supplies electrical power to the entire machine. To remove power to the machine, turn the disconnect handle to the OFF position. The disconnect handle should be turned off when the machine is not in use.

Figure 6-3: Disconnect Switch



WARNING	
	<p>When the disconnect switch is off, there is still live power to the disconnect switch's enclosure. Always turn off power at the main power source before opening electrical enclosure!</p>

Starting the Machine

Refer to the *Operating Procedure* section on page 29 for the operating procedure.

Indicators

Indicator Lights

The indicator lights listed in Table 6-1 provide the operator with information about the status of the machine.

Table 6-1: Functions of Indicators

	Function
Orange light, left side on top of operator controls	Indicates when hydraulic filter element needs to be replaced
Orange light, right side on top of operator controls	Indicates when the auto-raise function is enabled
Operator Station Active button	Dual-control systems only; illuminated pushbutton indicates which control station is currently active

Operator Control Interface

Figure 6-4: Overview of Control Mechanisms

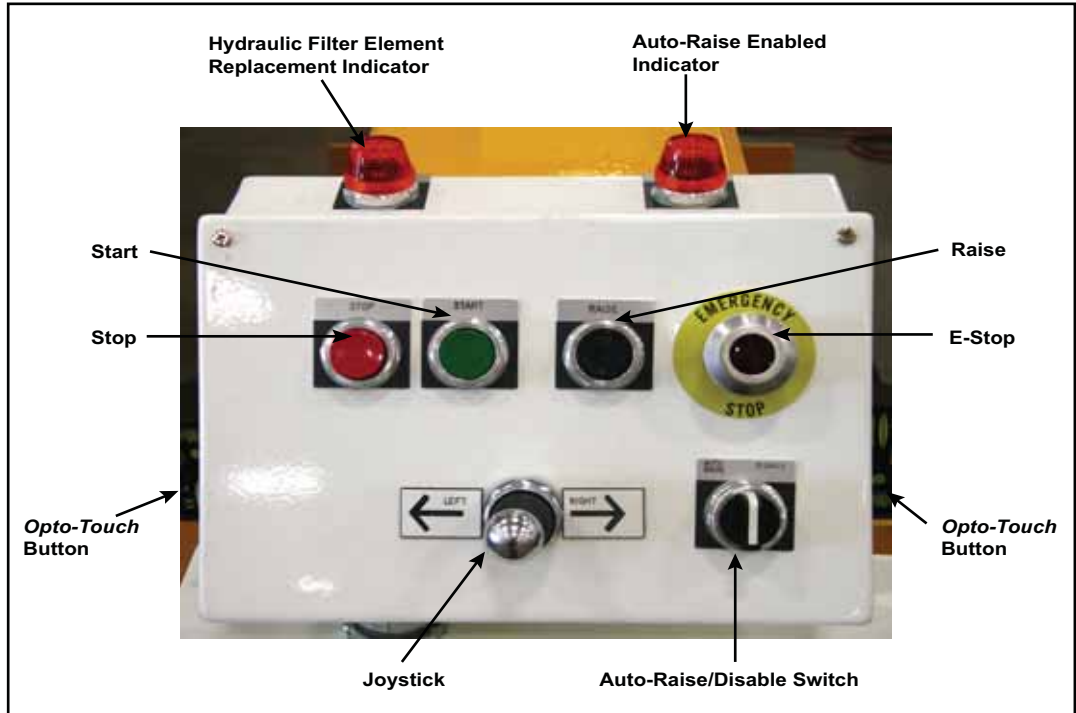

Table 6-2: Functions of Control Mechanisms

Mechanism	Function
Start button	Starts the hydraulic motor
Stop button	Stops the hydraulic motor
E-stop	Stops the pressing motion of the machine
Joystick	Controls left and right movement of the gantry head
Auto-Raise/Disable switch	Disables or enables the auto-raise function
<i>Opto-Touch</i> TM buttons	Momentary buttons; control the pressing action of the platen
Operator Station Active button	Dual-control systems only; illuminated pushbutton indicates which control station is currently active

Operating Procedure

WARNING	
	<p>CRUSH AND CUT HAZARD.</p> <p>Before turning on the equipment, make sure that all personnel and equipment are clear.</p>

Procedure Under Normal Conditions

1. Perform the safety tests described in the *Safety Test* section on page xviii or page xxxi upon initial daily startup.
2. Turn the disconnect handle to the ON (vertical) position.
3. For machines with the dual-control option, push the OPERATOR STATION ACTIVE button to activate the control station.
4. Press the START button to start the hydraulic motor.
 - In cold weather allow the pump and hydraulic fluid to warm up until they reach the recommended operating temperature. See Table 7-1 on page 41.
 - In extremely cold climates, it is recommended that you install an optional heater unit. Contact your MiTek Sales Representative for more information.
5. Turn the AUTO-RAISE/DISABLE switch to auto-raise to enable the auto-raise function. The switch will return to its center position, but the auto-raise indicator light will illuminate, indicating that the function is active.
6. Maneuver your U-channel jiggling into position, if applicable.
7. Set up the jack truss on the table.
8. Using the joystick, maneuver the gantry over a nail plate and joint.
9. Press the *Opto-Touch* buttons on each side of the operator control station to lower the platen and press the nail plates into the truss.

CAUTION	
<p>Do not attempt to move the gantry head while pressing the nail plates. Moving the gantry while pressing may result in damage to the machine.</p>	

10. Release the buttons. The platen will automatically raise.

11. Repeat steps 8 through 10 until each nail plate has been pressed securely into the truss material.
12. If you wish to set up another truss, repeat steps 6 through 11.
13. When you are finished building trusses, switch the AUTO-RAISE/DISABLE switch to Disable to lower the platen.



If the platen is left in the raised position, it will drift down over time. It is important to lower the platen when you are finished using the machine.

14. Press the STOP button.
15. If you will not be using the machine for an extended period of time, turn the disconnect handle to the OFF (horizontal) position.

Restart Procedure

1. If an E-stop has been depressed, reset the E-stop.
2. Press the START button to start the hydraulic motor.
 - In cold weather, allow the pump and hydraulic fluid to warm up until they reach the recommended operating temperature. See Table 7-1 on page 41.
 - In extremely cold climates, it is recommended that you install an optional heater unit. Contact your MiTek Sales Representative for more information.

Hydraulic System Operation

Hydraulic System Overview

The hydraulic motor controls the horizontal motion of the gantry. It is controlled by a solenoid valve. The pressing motion is controlled by two vertically-oriented hydraulic cylinders which are controlled by separate solenoid valves.

All return line flow passes through a cooler, which keeps the hydraulic fluid from overheating, and a filter, which removes contaminants from the fluid. A differential pressure switch on the filter indicates when the filter requires replacement.

Operating Overview

When the START button is pressed, the electric motor is started. This causes the hydraulic pump to begin pumping oil in the system, which allows the gantry to move and the platen to press the trusses.

When the joystick is operated, it actuates the solenoid for the hydraulic motor, allowing the gantry to move.

When the STOP button is pressed, the electric motor stops and the hydraulic pump stops pumping oil, stopping motion.

Purpose of Chapter

This chapter provides step-by-step instructions as well as information to help you understand how your equipment works to enable you to make repairs and perform preventive maintenance.

Introduction to Maintaining Your Equipment

This manual contains sufficient information for proper maintenance under most conditions. Certain operating environments may necessitate preventive maintenance at more frequent intervals. Because consistent preventive maintenance is so important for keeping mechanical equipment in good operating condition, MiTek recommends that you stock certain replacement parts to minimize downtime.

Review the table of contents and utilize the index to locate the information you need. The following appendices will also assist in maintaining and repairing your equipment:

- Troubleshooting
- Parts List
- Maintenance Checklists
- Drawing Set

Refer to Figure 7-1 for an overview of component locations that may require maintenance during the life of your equipment.

Read the *Performing Maintenance Safely* section before beginning maintenance on this equipment.

Performing Maintenance Safely

Read the safety pages in the preliminary pages and adhere to all rules and guidelines. This section provides additional safety information specific to maintenance topics.

Before Operating This Equipment

Adhere to these warnings before operating this equipment:

WARNING	
	<p>ELECTROCUTION, HIGH PRESSURE, CRUSH, CUT, AND CHEMICAL HAZARDS!</p> <p>Read this section AND the safety section in the preliminary pages before operating or maintaining this equipment.</p> <p>Do not operate this machine until you have a thorough understanding of all controls, safety devices, E-stops, and operating procedures outlined in this manual.</p> <p>Read and observe all warnings. Failure to do so may result in economic loss, property damage, and/or personal injury.</p> <p>This manual must always be available to personnel operating and maintaining this equipment.</p>



Lockout/Tagout

The lock and tag symbol shown here indicates that proper lockout/tagout procedures must be used prior to starting the procedure where the symbol occurs.

WARNING	
	<p>ELECTROCUTION AND HIGH PRESSURE HAZARDS.</p> <p>Always turn the power off by activating an E-stop when the equipment is not in operation.</p> <p>Always verify that all power to the machine has been turned off and follow approved lockout/tagout safety procedures (OSHA 29 CFR 1910.147) before performing any maintenance on this equipment.</p> <p>If it is absolutely necessary to troubleshoot an energized machine, follow NFPA 70E for proper procedures and personal protective equipment.</p> <p>Turn off the shutoff valve if appropriate.</p> <p>Bleed hydraulic lines if appropriate.</p>

Making Adjustments

Be careful when making mechanical adjustments. Untrained personnel may damage the machine or cause harm to themselves and others.

WARNING	
	<p>The components on this machine can cause severe injury if adjusted improperly. Follow all procedures in this manual thoroughly and do not make adjustments to the machine without guidance from MiTek or MiTek documentation.</p> <p>Only trained personnel should make mechanical adjustments to this machine.</p>

Replacing Parts

Special materials have been used for some of the components of this equipment. It is critical to the future performance of this machine that only specified replacement parts are used. Order all replacement parts through MiTek. Do not substitute parts without first consulting MiTek to determine if it is safe and effective. No electrical system component, cable, connector, or device should be modified, removed, disconnected, or changed without specific approval and guidance from MiTek.

Wearing Personal Protective Equipment

Follow OSHA guidelines regarding the proper personal protective equipment (PPE) while performing maintenance. The most common guidelines are in regards to eye protection, hearing protection, dust masks while blowing off sawdust, gloves while working with solvents, and fire-retardant clothing when troubleshooting an energized machine.

Conducting Safety Tests

Ensure safety devices are always operating properly. Perform the safety tests described in the *Safety Test* section on page xviii or page xxxi before operating the equipment at the initial startup, after performing any maintenance, and in accordance with the maintenance schedule.

Overview Graphics

Figure 7-1 provides an important overview of the equipment to help you better understand the procedures in the *Maintenance* chapter.

Figure 7-1: Gantry and Hydraulic Components Discussed in the *Maintenance* Chapter

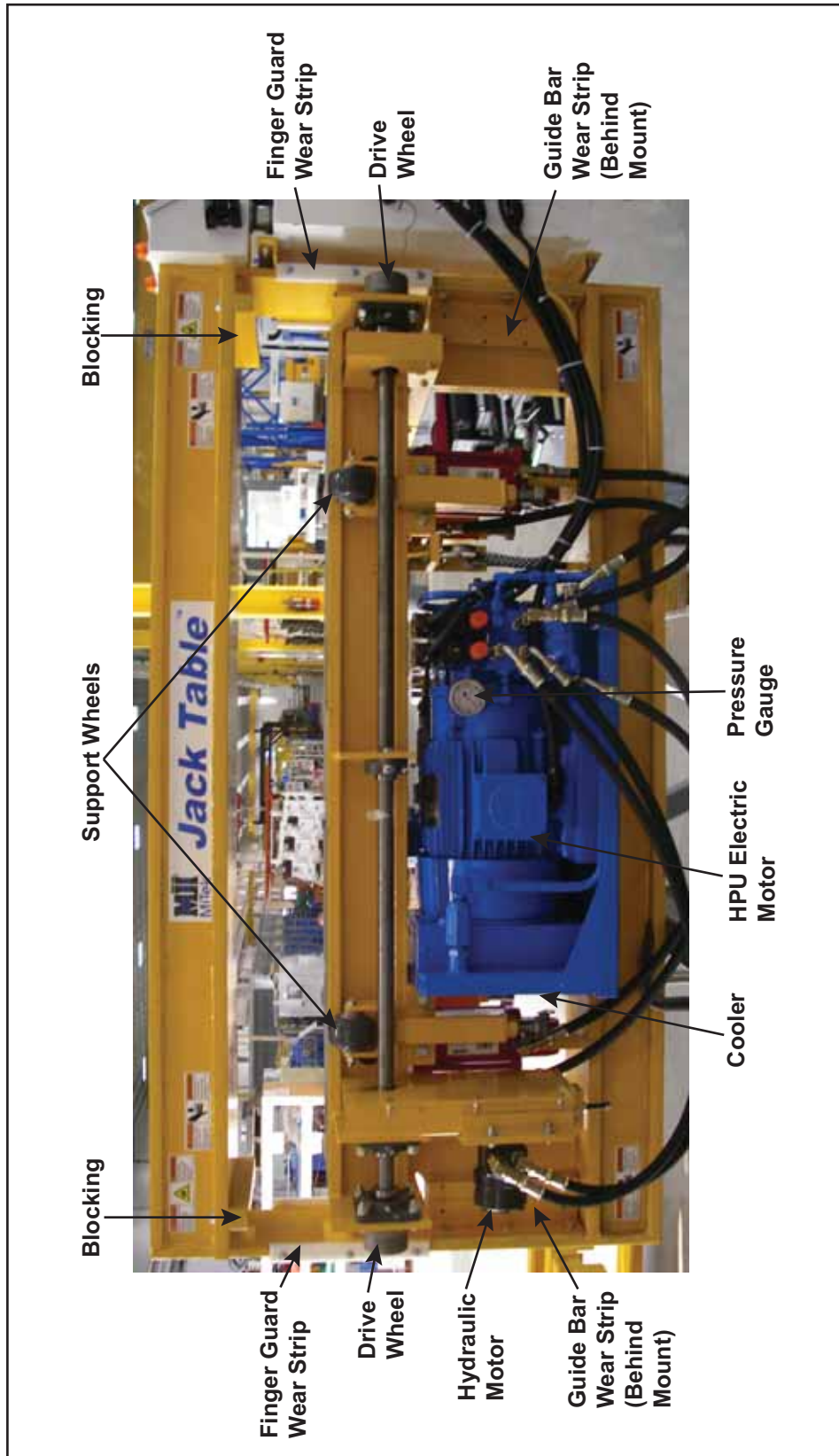

Operating Procedures for Maintenance Personnel

The platen should be in the lowered position for all maintenance unless specifically indicated otherwise.

After performing any maintenance that requires the hydraulic lines to be drained, cycle the cylinders and motors at least five (5) times before operating the system.

DANGER	
	<p>CRUSH HAZARD.</p> <p>Never climb under the table without first locking out and tagging the machine. If a pressing action is initialized, severe personal injury or death will result.</p>

WARNING	
	<p>CRUSH AND CUT HAZARD.</p> <p>Before turning on the equipment, make sure that all personnel and equipment are clear.</p>

Adjustments

Adjusting the Pressing Height

The press open height of the platen can be adjusted for pressing different lumber sizes. To adjust the press open height, adjust the position of the puck that activates the lever arm limit switch. To adjust the puck position:

1. Loosen the mounting bolt and move the puck to a lower or higher position. See Figure 7-2.
 - Moving the puck lower will cause the platen to raise to a lower height.
 - Moving the puck higher will cause the platen to raise to a higher height.
2. When the pressing height is properly adjusted, retighten the mounting bolt to secure the puck in place.
3. If the pressing height has been adjusted, you must replace the blocking. See *Replacing the Blocking* on page 66. Contact your MiTek Sales Representative to order additional blocking.

Figure 7-2: Limit Switch and Puck



Adjusting the Finger Guide Bars

CAUTION	
	<p>PINCH HAZARD.</p> <p>The finger guide bars should always be tight against the table. Failure to keep the finger guide bars tightened will result in a pinch point.</p>

1. Loosen the mounting bolts.
2. Press the finger guide bar so it is flat against the edge of the table.
3. Tighten the mounting bolts.

Adjusting the Support Wheel Pressure

The support wheels provide support to the underside of the table and hold the gantry drive wheels in contact with the track. See Figure 7-11 on page 58.

CAUTION

Improper adjustment of the support wheels could cause the wheels to slip while the gantry is driven.

To adjust the pressure of the support wheels, loosen the adjustment bolt to reduce support or tighten the adjustment bolt to increase support.



When the pressure is correctly adjusted, there should be 1-1/2 in. from the bottom of the weldment nut to the bottom of the adjustment bolt.

Cleaning, Lubricating, and Inspecting

Cleaning

DANGER	
	<p>CRUSH AND CUT HAZARD</p> <p>Guards must always be in place during operation to avoid serious injury and possibly death.</p> <p>Always replace guards after maintenance is complete and before removing the lockout/tagout device.</p>

Electrical enclosures must be vacuumed daily. U-channel jiggling slots should be blown out daily with compressed air.

CAUTION
<p>Do not use compressed air inside the electrical enclosures! It may force contaminants into the electrical connections.</p>

Figure 7-3: Never Use Compressed Air Inside an Electrical Enclosure



Lubricating

Proper amounts of motor oil and grease must be maintained at all times. The type of lubrication used, frequency of application, oxidation, and contamination of the lubricant affect service life and parts efficiency of gears and bearings. Improved performance will be obtained by following the guidelines in this manual. Lubrication guidelines are given in this chapter for each part or system that requires lubrication. The information is also in the *Maintenance Checklist* appendix.

There are synthetic fluids, synthetic blends, and hydrocarbon fluids (mineral). The synthetic fluids and synthetic blends are usually phosphate esters, chlorinated hydrocarbons, or a blend, sometimes including a small amount of hydrocarbon based oils. With these lubricants, special consideration must be given to the seals, pump performance, paints and any plastics in the system. In addition, the viscosity of synthetic fluids and synthetic blends is usually much lower than the viscosity of hydrocarbon (mineral) based fluids. The end result of the oil quality is unintelligible.

CAUTION
<p>Mixing synthetic lubricants with mineral lubricants is not recommended. Check with your lubricant supplier.</p>

Lubricating With Grease

Bearings

Grease all bearings weekly. Refer to the *Bearings* section for bearing locations and the procedure for lubricating them.

CAUTION

Do not overgrease the bearings. Excess grease may cause bearing seals to rupture.

Support Wheel Axles

Grease the support wheel axles weekly. See Figure 7-11 on page 58 for the location of the support wheel axles.

Chains

Use a high-grade, non-detergent, petroleum-base oil. Anti-foam, anti-rust, and film-strength improving additives are often beneficial. SAE 30 grade is recommended to lubricate the chains. Refer to the *Chains* section on page 60 for chain locations and the procedure for lubricating them.

Lubricating With Oil

Instructions and specifications for oil are described in the section for each specific component requiring oil.

Inspecting

Inspect the jiggling weekly for signs of wear and cracking. Replace any damaged jiggling immediately.

Check the light bulbs in the indicator lights monthly. Replace burned-out or damaged bulbs.

Hydraulic System

CAUTION	
	<p>HIGH PRESSURE HAZARD.</p> <p>Bleed all pressure from the lines before performing any maintenance on the hydraulic components.</p>

Hydraulic Fluid Specifications

Refer to Table 7-1 for hydraulic fluid specifications. See the footnote if operating outside the recommended temperature range.

Table 7-1: Recommended Hydraulic Fluid

Recommended Operating Viscosity Range	60-245 SUS	
Temperature	At Startup	> 68°F
	During Operation	86° to 120°F
ISO Grade ^a	32	
Reservoir Capacity	7 gal	
Capacity of Hydraulic Lines	2 gal	

- a. If operating outside of the recommended temperature range, select a hydraulic fluid that will operate at the proper SUS range for your temperatures.

Checking and Adding Hydraulic Fluid



Check the level of the hydraulic fluid in the reservoir every week by viewing the sight gauge on the hydraulic fluid reservoir.

To fill the reservoir, unscrew the reservoir cap and pour a recommended oil into the reservoir until the oil is within two (2) in. from the top of the reservoir. If pumping oil into the reservoir, you must remove the collar and screen underneath the cap.

Always replace the screen and cap immediately to prevent debris from falling into the reservoir.

Figure 7-4: Hydraulic Fluid Sight Gauge and Fill Cap





Replacing the Filter Element

Refer to Figure 7-5 for the location of the filter element.

Replace the filter element when the indicator light on top of the operator control station illuminates to indicate a filter change is necessary, and two weeks after the annual hydraulic fluid replacement.

To replace the filter element:

1. Remove the bolts in the filter cap.
2. Remove the filter cap.
3. Remove the old filter element.
4. Insert the new filter element.
5. Replace the filter cap.
6. Re-install and tighten the bolts.

Figure 7-5: Return Line Filter



Replacing the Hydraulic Fluid

The acceptable time between hydraulic oil changes depends on both the fluid used and the operating conditions involved.



In general, fluid should be changed when contaminated with water or dirt. Periodic laboratory analysis is the most accurate method to determine when and how often fluid should be changed. The supplier can often run these tests, or check the condition of the used oil. A trained maintenance mechanic can quickly determine the fluid level in the reservoir sight gauge and possible water contamination. Dirt and discolored oil both indicate that the oil should be changed. Additional indicators that the fluid must be changed are unusual noises, excessive temperatures, excessive vibration, leaking lines and fittings, and oil deposits on or around the machine.

Completely drain and refill the reservoir if you change the type of hydraulic oil in use.

At a minimum, it is recommended to completely drain and replace the hydraulic fluid annually. Always use a hydraulic fluid that matches the specifications described in Table 7-1 on page 41.

Tips for Replacing Hydraulic Fluid

- It is best to change hydraulic fluid when the system is at operating temperature. This will drain off as much of the impurities in suspension as possible.
- To eliminate the possibility of spillage, use a suction pump to remove the fluid from the reservoir. Some suppliers offer this service.
- Always replace the return line filter when changing the fluid, and again shortly thereafter.
- Completely drain and refill the reservoir if you change the type of hydraulic fluid in use.



Procedure for Replacing Hydraulic Fluid



New hydraulic fluid is not always filtered and may wear out the return line filters quickly. Ensure that you have a filter to be used as a replacement part shortly after replacing hydraulic fluid.

1. Remove the hydraulic reservoir breather cap.
2. Pump all hydraulic fluid out of the tank.
3. Remove the clean-out panel from the reservoir.
4. Wipe the entire inside of the tank clean with paper towels or clean rags.



The hydraulic valves are sensitive to debris. It is important to clean the tank completely by hand.

5. Re-install the cleaning panel. If the gasket appears to be damaged, replace it using RTV silicon gasket maker.
6. Fill the tank with the recommended hydraulic oil to 2 in. from the top. See Table 7-1 on page 41 for hydraulic fluid specifications.
7. Re-install the hydraulic reservoir breather cap.
8. Dispose of the used hydraulic fluid.

ENVIRONMENTAL

Always dispose of used hydraulic fluid in accordance with local, state, and federal laws.

Hydraulic Components

Reservoir

The reservoir contains the hydraulic fluid.

Electric Motor

The electric motor turns the hydraulic pump to create flow of hydraulic fluid. For replacement instructions, see *Replacing the HPU Electric Motor* on page 50.

Hydraulic Pump

The hydraulic pump removes oil from the reservoir and pumps it through the system. For replacement instructions, see *Replacing the Hydraulic Pump* on page 49.

Pressure Gauge

The pressure gauge shows the operating pressure for pressing and motor torque. The pressure gauge will only show pressure while you are moving the gantry head or pressing.



Relief Valve

The relief valves set the maximum pressure for the cylinders and hydraulic motor. To replace the relief valve:

1. Unscrew the relief valve cartridge.
2. Install a new relief valve cartridge.



Directional Valve

The directional valve controls the direction of the hydraulic motor rotation and the motion of the cylinders. To replace the directional valve:

1. Unbolt the directional valve.
2. Remove the damaged directional valve.
3. Put the new directional valve in place.
4. Bolt the valve in place and tighten the bolts.



Regenerative Valve (50-Ton Unit Only)

The regenerative valve allows the hydraulic fluid to cycle faster, compensating for the slower cycle time that would normally occur with the larger cylinders. To replace the regenerative valve:

1. Unscrew the regenerative valve cartridge.
2. Install a new regenerative valve cartridge.



Flow Divider

The flow divider separates the flow equally between the two hydraulic cylinders. To replace the flow divider:

1. Disconnect the hydraulic lines from the flow divider.
2. Unbolt the flow divider from its mount.
3. Remove the damaged flow divider.
4. Replace the flow divider.
5. Bolt the flow divider to its mount and tighten the bolts.
6. Reconnect the hydraulic lines.



Cooler

The cooler prevents the hydraulic fluid from overheating by using the fan motor to blow air across the coils. To replace the cooler:

1. Disconnect the hydraulic lines from the cooler.
2. Unbolt and remove the damaged cooler.
3. Replace the cooler.
4. Reconnect the hydraulic lines.

Return Line Filter

The return line filter element removes contaminants from the hydraulic fluid before returning it to the reservoir. An indicator light on the operator control panel illuminates when the filter requires replacement. For information on replacing the filter, see *Replacing the Filter Element* on page 42.



Check Valve

The check valve creates back pressure in the system, which allows the directional valves to shift. To replace the check valve:

1. Unscrew the damaged valve
2. Install a new valve.



Replacing the Hydraulic Motor

Removing the Hydraulic Motor

1. Move the gantry to the end of the table.
2. Lockout/tagout the machine.
3. Drain the hydraulic lines.
4. Remove the drive chain guard.
5. Relieve chain tension and remove the motor drive chain.
6. Remove the motor sprocket.
7. Remove the motor mount plate mounting bolts and motor mount plate.
8. Unbolt the hydraulic motor from the motor mount plate.
9. Disconnect the hydraulic lines from the motor.
10. Remove the hydraulic motor.

Re-installing the Hydraulic Motor

1. Replace the hydraulic motor.
2. Bolt the hydraulic motor onto the motor mount plate and tighten the bolts.
3. Put the motor mount plate back in place, and insert and tighten the motor mount plate mounting bolts.
4. Reconnect the hydraulic lines.
5. Put the motor sprocket back in place.
6. Re-install the motor drive chain.
7. Tension the motor drive chain. See *Adjusting the Motor Drive Chain Tension* on page 60.
8. Re-install the drive chain guard cover.
9. Remove the lockout/tagout devices and restart the machine.



Cycle the cylinders and hydraulic motor at least five (5) times before beginning normal operation.

Replacing the Hydraulic Cylinders



The platen MUST be up to remove the gantry from the table.



Removing the Hydraulic Cylinders

1. Remove the gantry from the table.
 - a) Support the table with a fork lift.

WARNING	
	<p>CRUSH HAZARD.</p> <p>Use caution when lifting the table. Fork lifts must be rated appropriately.</p> <p>Failure to exercise caution may result in severe personal injury or death.</p>

- b) Remove the bolts that attach the end legs to the main table frame. See Figure 7-6.
 - c) Remove the legs.
 - d) Remove the gantry from the table.
2. Support the trolley assembly with a forklift.
3. Drain the hydraulic lines.
4. Disconnect the hydraulic lines from the cylinders.
5. Remove the rod-end and cap-end clevis pins and retaining clips.
6. Remove the cylinder.

Figure 7-6: Removing the Table Legs



Re-installing the Hydraulic Cylinders

1. Replace the cylinder.
2. Re-install the rod-end and cap-end clevis pins and retaining clips.
3. Reconnect the hydraulic lines.

4. Put the gantry assembly back on the table.
 - a) Place the gantry on the table.
 - b) Re-install the legs.
 - c) Lower the table to the floor.
5. Remove the lockout/tagout devices and restart the machine.



Cycle the cylinders and hydraulic motor at least five (5) times before beginning normal operation.

Replacing the Hydraulic Pump



Removing the Hydraulic Pump

1. Close the ball valve and drain the hydraulic lines.
2. Disconnect the hydraulic lines from the pump.
3. Remove the cover over the pump motor housing.
4. Disconnect the couplings between the pump and the motor.
5. Unbolt the pump from the pump motor housing and remove the pump.

Re-installing the Hydraulic Pump

1. Replace the pump.
2. Reconnect the couplings between the pump and the motor.
3. Replace the cover over the pump motor housing.
4. Reconnect the hydraulic lines.
5. Open the ball valve.
6. Remove the lockout/tagout devices and restart the machine.



Cycle the cylinders and hydraulic motor at least five (5) times before beginning normal operation.

Replacing the HPU Electric Motor



Removing the HPU Electric Motor

1. Close the ball valve and drain the hydraulic lines.
2. Disconnect the hydraulic lines from the pump. See Figure 7-7.
3. Remove the cover over the pump motor housing.
4. Disconnect the couplings between the pump and the motor.
5. Unbolt the pump from the pump motor housing and remove the pump.
6. Remove the housing from the motor.
7. Unbolt the motor from the motor riser.
8. Disconnect the wiring, noting how the motor is wired.
9. Remove the motor.

Figure 7-7: HPU Electric Motor



Re-installing the HPU Electric Motor

1. Replace the motor.
2. Reconnect the wiring to match the previous wiring configuration.
3. Bolt the motor to the motor riser and tighten the bolts.
4. Re-install the motor housing.
5. Put the pump back in place.
6. Reconnect the couplings.
7. Bolt the pump to the pump motor housing and tighten the bolts.
8. Reconnect the hydraulic lines.
9. Open the ball valve.

10. Remove the lockout/tagout devices and restart the machine.



Cycle the cylinders and hydraulic motor at least five (5) times before beginning normal operation.

Hydraulic Adjustments

Adjusting the Operating Pressure for Pressing

1. Turn the auto-raise option off. The indicator light on the right side on top of the operator control should turn off.
2. Move the gantry to the end of the table so that the directional valves are accessible from outside the table. No personnel should not be under the table while maintenance personnel are performing this procedure.
3. Activate the pressing motion until the cylinders reach the end of their stroke and the pressure gauge stabilizes at maximum pressure.
4. Read the pressure on the pressure gauge. Note the reading.
5. Release the *Opto-Touch* buttons.
6. Turn off the power unit and lockout/tagout the machine.



The relief valve should be adjusted until the pressure is set at 2500 psi for the 30-ton hydraulic press or 2700 psi for the 50-ton hydraulic press..

7. Adjust the right relief valve. See Figure 7-8.
 - a) Loosen the lock nut on the relief valve.
 - b) Turn the adjustment screw clockwise to increase pressure or counter-clockwise to decrease pressure.
 - c) Tighten the lock nut.

Figure 7-8: Relief Valves

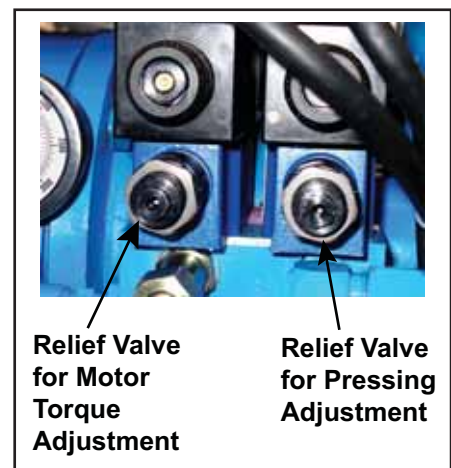

8. Remove the lockout/tagout devices and restart the machine.
9. Repeat steps 3 through 7 until the desired pressure is reached.

Adjusting the Operating Pressure for Motor Torque

1. Move the gantry toward the end of the table.
2. Inch the gantry toward the end of the table until it contacts the bumpers.
3. Continue holding the joystick so that the gantry is attempting to move against the bumpers.
4. Read the pressure on the pressure gauge. Note the reading.
5. Release the joystick.
6. Turn off the power unit and lockout/tagout the machine.



The relief valve should be adjusted until the pressure is set at 750 psi for the 30-ton hydraulic press or 1200 psi for the 50-ton hydraulic press.

7. Adjust the left relief valve. See Figure 7-8 on page 51.
 - a) Loosen the lock nut on the relief valve.
 - b) Turn the adjustment screw clockwise to increase pressure or counter-clockwise to decrease pressure.
 - c) Tighten the lock nut.
8. Remove the lockout/tagout devices and restart the machine.
9. Repeat steps 3 through 7 until the desired pressure is reached.

Bearings

Drive Shaft Bearings

The *Jack Table* has seven (7) drive shaft bearings, including four (4) wheel bearings, two (2) center support bearings, and one (1) motor support bearing. All bearings should be lubricated with grease weekly.

A drive shaft bearing is shown in Figure 7-9.

Figure 7-9: Bearing



CAUTION

Do not overgrease the bearings. Excess grease may cause bearing seals to rupture.

Replacing the Drive Shaft Bearings



The platen **MUST** be up to remove the gantry from the table.



Removing the Gantry, Drive Wheels and Chains

1. Remove the gantry from the table.
 - a) Support the table with a fork lift.

WARNING



CRUSH HAZARD.

Use caution when lifting the table. Fork lifts must be rated appropriately.

Failure to exercise caution may result in severe personal injury or death.

- b) Remove the bolts that attach the end legs to the main table frame. See Figure 7-6 on page 48.
- c) Remove the legs.
- d) Remove the gantry from the table.

It is recommended that you replace all drive shaft bearings when replacing one.



2. Remove the drive wheels.
 - a) Remove the outer snap ring.
 - b) Remove the wheel and key.
 - c) Remove the inner snap ring.
3. Remove the chain guards.
4. Relieve the tension on the motor drive chain.
5. Remove the motor drive chain and the transfer drive chain.

Removing the Bearings

1. Loosen all set screws in the sprockets.
2. Loosen all set screws between the bearings and the bearing collars.
3. Unbolt all bearings.
4. Note the location of all components. Remove the drive shaft.
5. Remove the bearings.

Re-installing the Bearings

1. Replace the bearings.
2. Replace the drive shaft and components in the same location as they were before removal.
3. Re-install and tighten the bearing bolts.
4. Re-insert and tighten the set screws between the bearings and the bearing collars.
5. Re-insert and tighten all set screws in the sprockets.

Re-installing the Chains, Drive Wheels, and Gantry

1. Re-install the motor drive chain and the transfer drive chain.
2. Tension the motor drive chain. See *Adjusting the Motor Drive Chain Tension* on page 60.
3. Re-install the chain guards.

4. Replace the drive wheels.
 - a) Replace the inner snap ring.
 - b) Re-install the wheel and key.
 - c) Replace the outer snap ring.
5. Put the gantry assembly back on the table.
 - a) Place the gantry on the table.
 - b) Re-install the legs.
 - c) Lower the table back to the floor.
6. Remove the lockout/tagout devices and restart the machine.

Wheels



It is recommended that you replace all drive wheels or support wheels when replacing one drive wheel or support wheel.

Replacing the Drive Wheels



The platen **MUST** be up to remove the gantry from the table.

1. Remove the gantry from the table.
 - a) Support the table with a fork lift.



It is recommended that you replace all drive wheels or support wheels when replacing one drive wheel or support wheel.

WARNING	
	<p>CRUSH HAZARD.</p> <p>Use caution when lifting the table. Fork lifts must be rated appropriately.</p> <p>Failure to exercise caution may result in severe personal injury or death.</p>

Figure 7-10: Drive Wheel



- b) Remove the bolts that attach the end legs to the main table frame. See Figure 7-6 on page 48.
 - c) Remove the legs.
 - d) Remove the gantry from the table.
2. Remove the drive wheels. See Figure 7-10.
 - a) Remove the outer snap ring.
 - b) Remove the wheel and key.
3. Replace the drive wheels.
 - a) Replace the wheel and key.
 - b) Re-install the outer snap ring.

4. Put the gantry assembly back on the table.
 - a) Place the gantry on the table.
 - b) Re-install the legs.
 - c) Lower the table back to the floor.
5. Remove the lockout/tagout devices and restart the machine.

Replacing the Support Wheels



The platen should be in the up position to replace the support wheels.

Figure 7-11: Support Wheel



Removing the Support Wheels

1. Move the gantry to the end of the table so the support wheels can be easily accessed.

WARNING	
	<p>CRUSH HAZARD.</p> <p>Personnel must not be under the table while replacing the support wheels. Block up the platen before attempting to replace the support wheels.</p> <p>Failure to exercise caution may result in severe personal injury or death.</p>

2. Block up the platen.
3. Loosen the adjustment bolt until there is no compression in the spring..
4. Unbolt the support assembly and remove it from the platen assembly. Refer to Drawing 30003-501.
5. Remove the nut from the end of the axle. See Figure 7-11.
6. Note the position of the spacer washers.
7. Remove the axle and wheel.

Re-installing the Support Wheels

1. Replace the wheel assembly.
2. Replace the axle and spacer washers.
3. Re-install and tighten the nut on the end of the axle.
4. Bolt the support assembly back to the platen assembly.
5. Tighten the adjustment bolt to tension the spring. See *Adjusting the Support Wheel Pressure* on page 38.
6. Remove the lockout/tagout devices and restart the machine.

Replacing the Support Wheel Die Spring



The platen should be in the up position to replace the support wheels.

1. Move the gantry to the end of the table so the support wheels can be easily accessed.

WARNING	
	<p>CRUSH HAZARD.</p> <p>Personnel must not be under the table while replacing the support wheels. Block up the platen before attempting to replace the support wheels.</p> <p>Failure to exercise caution may result in severe personal injury or death.</p>

2. Block up the platen.
3. Loosen the adjustment bolt until there is no compression in the spring.
4. Unbolt the support assembly and remove it from the platen assembly. Refer to Drawing 30003-501.
5. Slide the support assembly apart and remove the die spring.
6. Replace the die spring.
7. Put the support assembly back together.
8. Bolt the support assembly back to the platen assembly.
9. Tighten the adjustment bolt to tension the spring. See *Adjusting the Support Wheel Pressure* on page 38.
10. Remove the lockout/tagout devices and restart the machine.

Chains



Lubricating Chains

The drive chain and the transfer drive chain should be lubricated daily. The lubricant used should be a high-grade, non-detergent, petroleum-base oil. Anti-foam, anti-rust, and film-strength improving additives are often beneficial. SAE 30 grade is recommended.

To apply the oil, brush it on the inside surface of the chain. Apply it to the upper edges of the link plates in the lower span of the chain at a point close to where the chain engages a sprocket. Gravity and centrifugal force will aid in carrying the lubricant to the critical pin and bushing surfaces. Do not be concerned about surplus lubricant spilling over the link plate edges.



Adjusting the Motor Drive Chain Tension

1. Loosen the motor mount plate mounting bolts. See Figure 7-12.
2. Loosen lock nut on adjustment set screw.
3. Turn adjustment set screw clockwise to tighten chain tension or counter-clockwise to loosen.



There should be approximately 1/4-in. deflection in the chain between the two sprockets.

4. Retighten the lock nut on the adjustment set screw.
5. Retighten the motor mount plate mounting bolts.
6. Remove the lockout/tagout devices and restart the machine.

Figure 7-12: Motor Mount Plate Mounting Bolts and Adjustment Set Screw

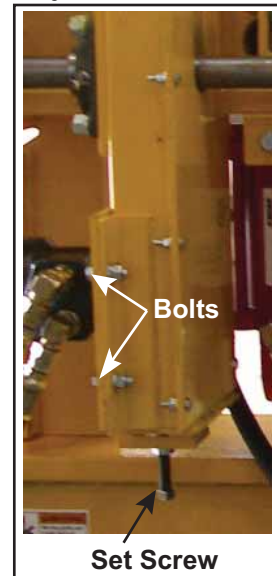

Replacing a Chain

Removing the Chain



1. Move the gantry head to a position where the master link is clear of the sprockets so it can easily be reached. The master link is shown in Figure 7-13.
2. Lower the platen.
3. Lockout/tagout the machine.
4. Remove the chain guards.
5. Note how the chain is threaded around the sprockets. If replacing the transfer chain, note how the chain is threaded through the hole in the gantry.
6. Loosen the set screw to relieve tension per the *Adjusting the Chain Tension* section.
7. Remove the master link on the chain by pulling out the two (2) pins using pliers. The chain will come apart and can be removed from the sprockets.

Figure 7-13: Master Link on a Chain

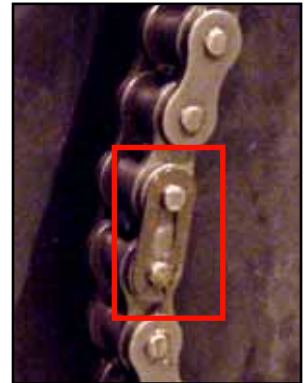

Replacing the Chain

1. Thread the new chain around the sprockets. Thread the new chain through the hole in the gantry if replacing the transfer chain.
2. Connect the chain to itself by placing the master link between two links and pressing together with pliers.
3. Adjust the tension sprocket for the motor drive chain. See *Adjusting the Motor Drive Chain Tension* on page 60.



There should be approximately 1/4-in. deflection in the chain between the two sprockets.

4. Re-install the chain guards.
5. Remove the lockout/tagout devices and restart the machine.

Wear Strips

If the pressing motion of the platen is no longer vertical, the wear strips should be replaced. There are six wear strips.

You should replace one wear strip at a time. Do not begin replacing other wear strips until the replacement of the first wear strip is complete.



Replacing the Finger Guard Wear Strips

1. Remove the bolts from the finger guard wear strips. See Figure 7-14.
2. Remove the damaged wear strip.
3. Replace the wear strip.
4. Re-insert and tighten the bolts.
5. Remove the lockout/tagout devices and restart the machine.

Figure 7-14: Finger Guard Wear Strip



Replacing the Guide Bar Wear Strips



WARNING	
	<p>CRUSH HAZARD.</p> <p>Remove only one guide bar wear strip at a time. Removing more than one guide bar wear strip may cause the trolley assembly to fall out of the platen assembly, which could result in severe personal injury or death and damage to the machine.</p>

1. Remove the guide bar wear strip bracket.
2. Remove the bolts that hold the wear strip in place.
3. Remove the old wear strip.
4. Put the new wear strip in place.
5. Re-insert and tighten the bolts.
6. Re-install the guide bar wear strip bracket.

Figure 7-15: Guide Bar Wear Strip (30-ton Shown)



Replacing the End Guide Bar Wear Strips



The platen MUST be up to remove the gantry from the table.

1. Remove the gantry from the table.
 - a) Support the table with a fork lift.

WARNING	
	<p>CRUSH HAZARD.</p> <p>Use caution when lifting the table. Fork lifts must be rated appropriately.</p> <p>Failure to exercise caution may result in severe personal injury or death.</p>

- b) Remove the bolts that attach the end legs to the main table frame. See Figure 7-6 on page 48.
 - c) Remove the legs.
 - d) Remove the gantry from the table.
 2. Remove the trolley assembly from the outer frame.
 - a) Disconnect hydraulic lines connecting the trolley to the HPU.
 - b) Disconnect the cylinder rod end from the trolley by removing the retaining pins and clevis pin from rod-end clevis.
 - c) Support the trolley assembly with a forklift on the side opposite the motor.
 - d) Remove the guide bar wear strip brackets one both ends of the machine from the side opposite the motor.
 - e) Raise the trolley assembly off of the cylinder clevises and remove from the platen assembly.
 3. Remove the end guide bar wear strips. Refer to Figure 7-1 for wear strip locations.
 4. Replace the end guide bar wear strips.
 5. Re-install the trolley assembly in the outer frame.
 - a) Position the trolley assembly in the outer frame.
 - b) Re-install the guide bar wear strip brackets on both ends of the machine from the side opposite the motor.
 - c) Reconnect the cylinder rod end to the trolley using the retaining pins and clevis pin from the rod-end clevis.
 - d) Reconnect the hydraulic lines.
 6. Put the gantry assembly back on the table.
 - a) Place the gantry on the table.
 - b) Re-install the legs.
 - c) Lower the table back to the floor.

7. Remove the lockout/tagout devices and restart the machine.



Cycle the cylinders and hydraulic motor at least five (5) times before beginning normal operation.

Jigging and Blocking

The jigging is designed for durability and accuracy with minimal maintenance. It is important, however, to promptly remove from service any damaged fixtures or components. Damage may occur if the jigging is hit with a heavy object, dropped on the floor, or from daily wear. If damaged components are not replaced immediately, they may cause damage to other threaded parts as well as inaccuracies in the trusses built with those components.

Available Jigging

Pucks, socket head cap screws, and U-channel nuts are available for any U-channel *Jack Table*.

Stocking Replacement Jigging

It is a good idea to stock extra jigging to ensure the jigging in operation is in optimum condition. As part of your annual preventive maintenance, we recommend taking inventory of all jigging you are currently using or have in stock. Replace any damaged jigging at this time.

CAUTION

Jigging should not be used where it could be under the blocking during pressing. Damage to jigging and U-channels may occur.



Replacing the Blocking

The *Jack Table* is shipped with blocking for 2-in. lumber. To press thicker lumber, you will need to replace the blocking with optional blocking for 3-in. or 4-in. lumber. Contact your MiTek Sales Representative to order additional blocking.

Figure 7-16: Blocking



The platen must be raised to replace the blocking.

1. Block up the platen to ensure it is adequately supported.
2. Remove the two bolts that hold the blocking in place.

CAUTION	
	<p>CRUSH HAZARD.</p> <p>The blocking is heavy. Use caution when handling the blocking.</p>

3. Remove the blocking from the platen.
4. Place the new blocking against the platen so the bolt holes in the blocking line up with the bolt holes in the gantry.
5. Insert and tighten the bolts.



Bumpers

To replace the bumpers:

1. Unbolt the bumpers.
2. Remove the damaged bumpers.
3. Replace bumpers.
4. Re-insert bolts and tighten.

Figure 7-17: Bumpers



Electrical Components



Replacing Light Bulbs

To remove the light cover, simply unscrew it. To replace the light bulb under the light cover, gently push in and turn the light bulb counterclockwise. It will come loose within 1/2 turn.

Figure 7-18: Indicator Light



Motor Starters and Overloads

Motor starters turn motors on and off. Overloads are usually mounted to the output side of the motor starter and act as safety switches.

Cleaning Contacts

To clean the motor starter contacts:

CAUTION

Never use pneumatic air inside electrical cabinets. It will force dust and particles into electrical components causing them to fail.

1. Activate an E-stop. The starter will release (open) and the dust may be forced out.
2. If the problem continues, activate an E-stop again.
3. Lockout/tagout at the wall before opening the enclosure.
4. Use canned air to blow dust from contacts. **DO NOT USE PNEUMATIC AIR FROM YOUR PLANT!**
5. Cycle the contacts up and down with a small screwdriver.
6. Vacuum the enclosure.



Environmental Temperature

The air temperature around the *Jack Table* should never exceed 110°F. In high ambient temperatures, the motors are unable to dissipate heat effectively. When the temperature of the motor windings exceeds a preset value, the motor overload will automatically shutdown the motor to prevent it from burning up.

Navigating the Troubleshooting Appendix

Refer to...
Maintenance chapter for procedures and graphics
General Information chapter for truss terminology
Glossary for additional terminology
Figure 1-1 to contact MiTek Machinery Division Customer Service

If you continue to have problems after performing all applicable troubleshooting steps and reviewing the topic in the *Maintenance* chapter, call MiTek Machinery Division Customer Service for assistance.

Safety Notes for Troubleshooting

General Troubleshooting Safety Tips

WARNING	
	<p>ELECTROCUTION, HIGH PRESSURE, CRUSH, CUT, AND CHEMICAL HAZARDS!</p> <p>Read all notes in this section AND the safety section in the preliminary pages before operating or maintaining this equipment.</p> <p>Most solutions are described in more detail in the <i>Maintenance</i> chapter and may have more safety notes included there.</p>



- **Read all warnings** located in the safety section in the preliminary pages and adhere to them at all times.
- **When this graphic appears, lockout/tagout at the disconnect switch located on the equipment** using approved methods described in OSHA 29 CFR 1910.147 before continuing with the procedure or troubleshooting.
- If the lockout/tagout graphic does not appear, it is recommended that you still **de-energize the machine** unless energy is required for the troubleshooting process. If it is absolutely necessary to troubleshoot an energized machine, follow NFPA 70E for proper procedures and personal protective equipment.
- **All electrical work must be performed by a licensed electrician.**
- **Read this manual** for information and procedures related to the specific maintenance or troubleshooting issue before attempting any maintenance!
- **Safety goggles and a dust mask** must be worn for all cleaning steps outlined in this manual. When using cleaning and lubrication solutions, a respirator rated for use with those solutions must be worn as well as gloves resistant to the solution.

Electrical Troubleshooting Safety Tips

- **Make sure you have the proper tools needed for the job.** See *Tools Needed* on page 71.
- **Ensure the person performing the troubleshooting is qualified** from an electrical knowledge standpoint. If you feel uncertain about troubleshooting electrical power, remember, it is better to spend money to hire an electrician than to risk an injury.
- **Remove rings and watches that you are wearing.** They are extremely conductive material and may catch on small components.
- **Get a helper.** You are most likely going to need a third hand at some point, and you shouldn't perform electrical work without someone close by to help if you get hurt.
- **Be patient.** Take your time and stay alert. Never shortcut or become too confident in what you are doing; electrical power will always be stronger than you.
- **Take notes** recording what you have checked, and what the readings were. This is also a good way to check your work when you are finished. Sometimes, the machine won't work because a wire was removed for testing, and overlooked when cleaning up. Having proper notes will make the process go much more smoothly.
- **ALWAYS turn the power off** if you are checking for ohms or swapping PLC cards.
- **ALWAYS push an E-stop button** before approaching a machine for any reason, but if you are working with the encoders it is especially important. An interruption to a powered encoder may cause components to move without warning.
- **Wear appropriate personal protective equipment (PPE)** for working with live power.

Getting Started With Troubleshooting

Tools Needed

Gather these tools before beginning the troubleshooting process and before calling MiTek for technical assistance.

1. Slotted screwdriver, insulated
2. Phillips screwdriver, insulated
3. Equipment manual and drawings, specifically electrical schematics
4. Pen and paper to take notes and document settings
5. Multimeter

A multimeter is an electronic measuring instrument. The analog versions were referred to as an analog volt-ohm-meter (VOM). A newer, digital model is called a digital-multi-meter (DMM). There are a large variety of volt-measuring devices available, but at a minimum, it should have these features:

- Voltage (volts) measurement
 - Resistance (ohms) measurement
 - Ability to measure both AC and DC power
 - Autoranging feature
 - It is highly beneficial to also have the ability to measure current (amps)
6. Various additional tools depending on which parts are in question
 7. Personal protective equipment as dictated by NFPA 70E

The First Steps

For Mechanical Troubleshooting

Always clean and lubricate the equipment as a first step in most troubleshooting processes. Most mechanical malfunctions are caused by inadequate preventive maintenance.

For Electrical Troubleshooting

1. Lockout/tagout at the disconnect switch located on the equipment.

CAUTION	
	<p>Do not use compressed air inside the electrical enclosures! It may force contaminants into the electrical connections. You may use canned air, which has a much lower compression than your plant air.</p>

2. Vacuum and dust the electrical enclosure.
3. Remove the lockout/tagout equipment and attempt to run the machine again. If that didn't fix the problem, proceed with the next step.
4. Adhere to all regulations and guidelines given in NFPA 70e and in your company's energy control program. Some important safety tips are also addressed on page 70.

Figure A-1: Never Use Compressed Air Inside an Electrical Enclosure



WARNING	
	<p>ELECTROCUTION HAZARD!</p> <p>All electrical work must be performed by a licensed electrician.</p> <p>If it is absolutely necessary to troubleshoot an energized machine, follow NFPA 70E for proper procedures and personal protective equipment.</p>

5. Determine where the electrical problem begins. To do this, you need a multimeter. If you are unfamiliar with your multimeter, consult the manufacturer's manual.
 - Determine if you are working with AC (alternating current) or DC (direct current) before checking for voltage. Your multimeter should measure both, but you'll have to tell it which one to measure.
 - Measure incoming and outgoing voltage to specific components. Proceed along a logical order determined by your machine's specific problem, and write down the order that you check each item and the amount of voltage that it registers.

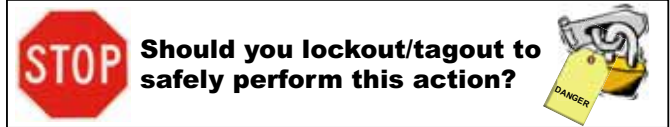

Symptoms and Solutions

Table A-1: Jack Table Troubleshooting

Problem	Possible Cause	Possible Solution	See Page
Platen not square with the table top	Wear strips are damaged	Replace the wear strips	53
	Gantry trolley not sitting flat on the table	Check to make sure the drive wheels are sitting flat; remove debris	—
Gantry does not move or moves slowly	Motor drive chain not properly tensioned	Retension motor drive chain	60
	Limit switch has failed or platen not up	Replace the limit switch	—
		Check the location of the puck	37
	Motor torque operating pressure is set too low	Reset motor torque operating pressure	52
	Support wheels are not properly tensioned	Retension support wheels	38
	Drive chain is broken	Replace drive chain	60
	Transfer chain is broken	Replace transfer chain	60
	Keyway is broken	Replace keyway	—
	Bearings are locked	Replace bearings	53
	Joystick is broken	Have an electrician check electrical circuit; Replace joystick	—
	Relief valve has backed off	Have hydraulic personnel check the hydraulic system	—
	Low or no oil in tank	Refill tank to correct level	41
The electric motor is running backwards	Have an electrician check the motor/pump rotation and correct, if necessary	—	
HPU motor and pump will not start	Main power is turned off	Turn on main power	—
	Main disconnect switch is turned off	Turn on the main disconnect switch	—
	E-stop is depressed	Reset the E-stop and press the START button	—
	Festoon cable is damaged	Replace festoon cable	—
	Motor starter contacts are damaged	Clean contacts	68
Hydraulic cylinder is leaking around the rod and gland	Rod gland seals are worn	Replace gland seals; Repair/replace cylinder rod	—
	Rod has burr which damages gland seals	Repair/replace cylinder rod; Replace gland seals	—



Table A-1: Jack Table Troubleshooting (Continued)

Problem	Possible Cause	Possible Solution	See Page
Platen will not press	Obstruction under the platen	Clear obstruction	—
	Cylinder is broken	Replace cylinder	48
	Platen is moving	Stop moving platen before pressing	—
Gantry will not move and platen will not press	Main power is turned off	Turn on main power	—
	Main disconnect switch is turned off	Turn on the main disconnect switch	—
	E-stop is depressed	Reset the E-stop and press the START button	—
	<i>Opto-Touch</i> buttons have failed	Contact MiTek Machinery Division Customer Service	—
	HPU has not started	Start the HPU	29
Plates are not properly embedded in the truss material	Operating pressure for pressing is too low	Reset pressure	51
	Incorrect blocking being used	Replace blocking	66
Platen moving side-to-side abnormally or excessively in trolley	End guide bar wear strips are damaged	Replace end guide bar wear strips	63
Gantry crashing loudly at end of table	Bumpers are damaged	Replace bumpers	67
Table sags in the center	Support wheels are not properly tensioned	Retension support wheels	38
Platen presses slowly	Pressure is set incorrectly	Set pressure correctly	51
	Regenerative valve has failed (50-ton press only)	Replace regenerative valve	45

Ordering the Parts With Your Part Number

There are several easy ways to order your part after you determine the part number. Each column in Table B-1 describes one method.

Table B-1: How to Order Your Part Using the Part Number

Using Our eStore™ (an account is required)	Using E-Mail	Using the Phone
<p>Access our on-line eStore using one of the following methods:</p> <p>Click the eStore link from the Web site OR</p> <p>Click the eStore link from the Parts Guide OR</p> <p>Type http://estore.mii.com into your web browser</p>	<p>Send an e-mail to mitekparts@mii.com with all relevant information, including the part number.</p>	<p>Call 1-800-523-3380 and select "Parts Orders".</p>

Safety Notes for Replacing Parts

CAUTION	
<p>Only use the exact replacement parts that are specified by MiTek. Substitutions may harm your equipment.</p>	

WARNING	
	<p>CRUSH, CUT, ELECTROCUTION, HIGH PRESSURE AND CHEMICAL HAZARDS.</p> <p>Perform the safety tests described in the <i>Safety Test</i> section on page xviii or page xxxi before operating the equipment at the initial startup, after performing any maintenance, and in accordance with the maintenance schedule.</p>

WARNING	
	<p>ELECTRICAL HAZARD!</p> <p>All electrical work must be performed by a licensed electrician.</p> <p>Follow approved lockout/tagout procedures (OSHA 29 CFR 1910.147).</p>

WARNING	
	<p>ELECTROCUTION AND HIGH PRESSURE HAZARDS.</p> <p>Always turn the power off by activating an E-stop when the equipment is not in operation.</p> <p>Always verify that all power to the machine has been turned off and follow approved lockout/tagout safety procedures (OSHA 29 CFR 1910.147) before performing any maintenance on this equipment.</p> <p>Turn off the shutoff valve if appropriate.</p> <p>Bleed hydraulic lines if appropriate.</p>



Part Numbers

Table B-2: Replacement Parts

Part Location Category	MiTek Part #	Part Description	Refer to Drawing #	Keep in Stock
Gantry	30035	Drive wheel	30006-501	4
Gantry	30044	End guide bar	30003-501	—
Gantry	30045	Guide bar	30003-501	—
Gantry	30068	Finger guard bar	30003-501	—
Gantry	515043	Limit switch, lever	30003-501	—
Gantry	370002	Die spring	30010-501	2
Gantry	419112	Flange bearing	30006-501	5
Gantry	419134	Flange bearing, 2-bolt	30006-501	2
Gantry	554006-16.37	Chain, 16-3/8"	30006-501	—
Gantry	554006-27.50	Chain, 27-1/2"	30006-501	—
Gantry	580006	Support wheel	30010-501	2
Hydraulic assembly	30005-501	Hydraulic assembly, 30-ton press	30005-501	—
Hydraulic assembly	30095-501	Hydraulic assembly, 50-ton press	30095-501	—
Hydraulic assembly	30055-501	HPU assembly, 30-ton press	30005-501	—
Hydraulic assembly	30096-501	HPU assembly, 50-ton press	30096-501	—
Hydraulic assembly	438022	Filter element	30005-501	—
Hydraulic assembly	798002	Cylinder, 30-ton press	30003-501	1
Hydraulic assembly	798005	Cylinder, 50-ton press	30005-501	1
Hydraulic assembly	807001	Hydraulic motor	30003-501	1
Table	30066	U-channel rail	30002-501	—
Table	30076	Puck	30002-501	5
Table	200011	Nut	30002-501	5
Table	326365	Socket head cap screw	30002-501	5
Table	446152	Rubber bumper	30002-501	—

Navigating the Maintenance Checklists

These checklists guide you through all preventive maintenance tasks required to keep this equipment in top working condition.

These pages are supplied with the intent that you will photocopy them and leave the original in the manual for future use. Space is provided in each chart to place the date that the work is done and the initials of the person performing the work.

Checklist	Page
Daily Checklist	80
Weekly Checklist	81
Monthly and Annual Checklists	82

Safety Notes For Maintenance Checklists

WARNING	
	<p>CRUSH, CUT, ELECTROCUTION, HIGH PRESSURE AND CHEMICAL HAZARDS.</p> <p>Perform the safety tests described in the <i>Safety Test</i> section on page xviii or page xxxi before operating the equipment at the initial startup, after performing any maintenance, and in accordance with the maintenance schedule.</p>

WARNING	
	<p>ELECTROCUTION AND HIGH PRESSURE HAZARDS.</p> <p>Always turn the power off and activate an E-stop when the equipment is not in operation.</p> <p>Always verify that all power to the machine has been turned off and follow approved lockout/tagout safety procedures (OSHA 29 CFR 1910.147) before performing any maintenance on this equipment.</p> <p>Turn off the shutoff valve if appropriate.</p> <p>Bleed hydraulic lines if appropriate.</p>

Jack Table™

Daily Checklist

Month and Year: _____ Week: _____

Action		See Page	Dates						
Vacuum the electrical enclosures	Shift 1								
	Shift 2								
	Shift 3								
Blow out the U-channel jiggling slots with compressed air	Shift 1								
	Shift 2								
	Shift 3								
Lubricate the drive chain and transfer drive chain	Shift 1								
	Shift 2								
	Shift 3								

Notes	Date
_____	_____
_____	_____
_____	_____
_____	_____

Jack Table™

Weekly Checklist

Year: _____

Month: _____

Action	See Page	Dates				
Grease all bearings						
Grease the support wheels axles						
Inspect all jiggig; replace as needed						
Check hydraulic fluid levels						

Notes

Date

Jack Table™

Monthly and Annual Checklists

Year: _____

Action	Interval	See Page	JAN	FEB	MAR	APRIL	MAY	JUNE
Check indicator light bulbs	1 month							
Check chain tension	1 month							
Replace hydraulic fluid	1 year							

Action	Interval	See Page	JULY	AUG	SEPT	OCT	NOV	DEC
Check indicator light bulbs	1 month							
Check chain tension	1 month							
Replace hydraulic fluid	1 year							

This appendix provides general information that will help you better understand how this equipment works.

Understanding Overloads

Purpose and Scope

The information below has been collected to help you understand the role of an overload, how an overload works, and how to calculate the overload setting to protect the motor.

The Importance of Protecting Your Motor

The following statement describes the importance of protecting electric motors and is a good illustration of why we need overloads.

Proper Motor Protection Safeguards Your Investments

With electric motors driving the majority of today's manufacturing processes, proper motor protection is critical. Not surprisingly, a significant amount of effort and resources have recently been invested in motor protection technology, resulting in cost-effective solutions to many of today's common motor problems.

Motors fail for a number of reasons—moisture and contamination, short circuits, mechanical problems and old age—but the primary reason is excessive heat, caused by excess current (greater than normal motor full load current), high ambient temperatures, and poor ventilation of the motor. If a motor is continuously overheated by only 10 degrees, its life can be reduced by as much as 50%.

Steve Zimmerman
Control Engineering
December 1, 1997

What is an Overload?

So, what is an overload? The term literally means that too much load (what the motor is driving) has been placed on the motor. A motor is designed to run at a certain speed, called its synchronous speed. If the load on the motor increases, the motor draws more current to continue running at its synchronous speed.

It is quite possible to put so much load on a motor that it will draw more and more current without being able to reach synchronous speed. If this happens for a long enough period of time, the motor can melt its insulation and burn out, resulting in damage to the motor windings. This excessive load condition is called an overload.

In fact, the motor could stop turning altogether (called a locked rotor) under a large enough load. This is another example of an overload condition. Even though the motor shaft is unable to turn, the motor continues to draw current, attempting to reach its synchronous speed.

Although the running motor may not draw enough current to blow the fuses or trip circuit breakers, it can produce sufficient heat to burn up the motor. This heat, generated by excessive current in the windings, causes the insulation to fail and the motor to burn out. We use the term “locked rotor amps” to describe when the motor is in this state and is drawing the maximum amount of current.

Due to the possibility of excessive current draw, an overload protection device is required that does not open the circuit while the motor is starting, but opens the circuit if the motor gets overloaded.

Starting Current

When a motor is started, it must perform work to overcome the inertia of the rotating portion of the motor and the attached load. The starting current measured on the incoming line is typically 600% of full-load current when rated voltage and frequency is first applied to a NEMA B motor. The stationary portion of the motor current decreases to its rated value as the rotor comes up to speed.

Figure D-1: Motor Inrush Curve

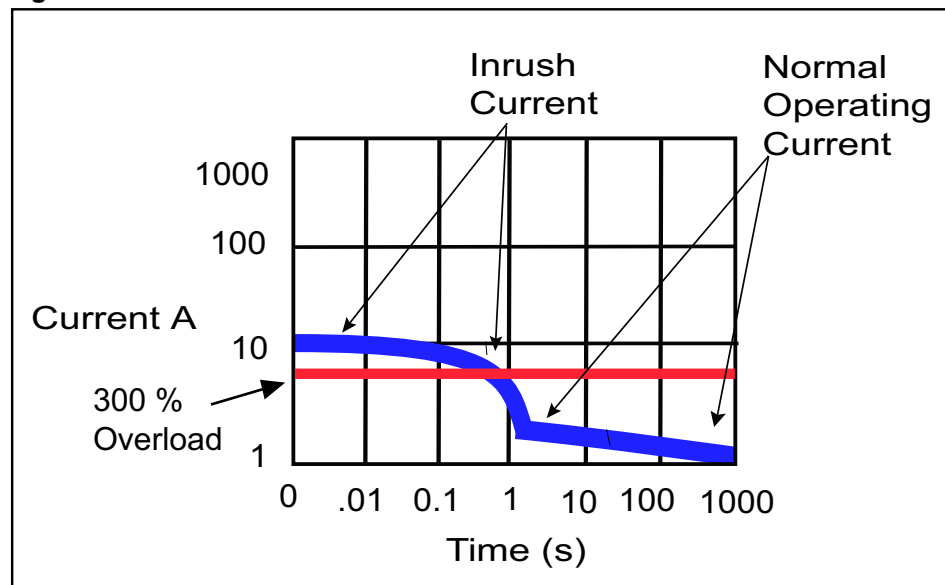

An overload condition will occur when the rotor has difficulty turning and draws more current than it normally would need to keep it turning. When an overload occurs the current being drawn is usually between 2 to 6 times the normal operating current.

For example if a conveyor belt becomes jammed and does not allow the rotor to turn, the motor will draw about as much amperage as it would on startup to try to get the rotor to turn. As long as the rotor does not turn, this increased current will continue to flow. The key thing to remember in an overload condition is that the current flows through the normal circuit path. Continued overload current will cause excess heating in the motor and the motor circuit. If the over current protective device does not operate in a timely manner, the motor could short out a winding, or cause insulation damage to a winding which could lead to a short circuit later.

Overload Relays

The overload relay is the device used in starters for motor overload protection. It limits the amount of current drawn to protect the motor from overheating.

An overload relay consists of:

- A current sensing unit (connected in the circuit to the motor)
- A mechanism to break the circuit, either directly or indirectly

Overload relays have the following features:

- A time delay which ignores harmless temporary overloads caused by normal motor starting, without breaking the circuit
- A means of resetting the circuit once the overload is removed

- A design that meets the special protective needs of motor control circuits
- Allow harmless temporary overloads, such as motor starting, without disrupting the circuit
- Will trip and open a circuit if current is high enough to cause motor damage over a period of time
- Can be reset once the overload is removed

Bimetallic Overload Relays

Overload protection is accomplished with the use of a bimetallic strip. This component consists of a small heater element wired in series with the motor and a bimetallic strip that can be used as a trip lever. A bimetallic strip is made of two dissimilar metals bonded together. The two metals have different thermal expansion characteristics, so the bimetallic bends at a given rate when heated.

Under normal operating conditions the heat generated by the heater element will be insufficient to cause the bimetallic strip to bend enough to trip the overload relay.

As current rises, heat also rises. The hotter the bimetallic becomes, the more it bends. In an overload condition the heat generated from the heater will cause the bimetallic strip to bend until the mechanism is tripped, stopping the motor.

If heat begins to rise, the strip bends, and the spring pulls the contacts apart, breaking the circuit, as shown in Figure D-2.

Figure D-2: The Warping Effect of the Bimetallic Strip

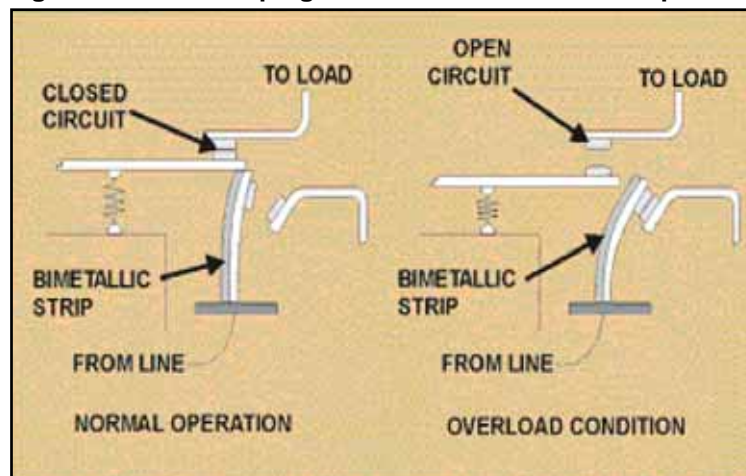

Once the tripping action has taken place, the bimetallic strip cools and reshapes itself, automatically resetting the circuit. The motor can be restarted even when the overload condition has not been cleared, and will trip and reset itself again and again. (This assumes an automatic reset and can also be equipped with a manual reset.)

Electronic Overload Relay

Electronic overload relays are another option for motor protection. The features and benefits of electronic overload relays vary but there are a few common traits. One advantage offered by electronic overload relays is heater-less design. This reduces installation cost and the need to stock a variety of heaters to match motor ratings. Electronic overload relays can detect a phase loss and disconnect the motor from the power source. This feature is not available on mechanical types of overload relays.

Overload Classifications

Overload relays also have an assigned trip class. The trip class is the maximum time in seconds at which the overload relay will trip when the carrying current is at 600% of its current rating. Bimetallic overload relays can be rated as Class 10, meaning that they can be counted on to break the circuit no more than ten seconds after a locked rotor condition begins. Melting alloy overload relays are generally *Class 20*.

American industry has standardized on Class 20 overload protection. The Europeans have standardized on Class 10.

Class 20 will give a nominal 590-second trip (9.83 minutes) at an overload of 125% of full load amps, a 29-second trip at a 500% overload, and a 20-second trip at a 600% overload. Thus, a motor that is stalled and drawing locked rotor amperage will be taken off-line in 20 to 29 seconds. However, a motor that draws a continuous locked rotor current can be expected to burn out before 20 seconds.

Class 10 will give a nominal 230-second trip (3.83 minutes) at 125% overload, 15 seconds at 500% overload, and 10 seconds at 600% overload.

Class 30 has a longer time delay to be used on high inertia loads that require a long acceleration or have shock loading that causes repetitive motor inrush.



The overload class that *MiTek* normally specifies for equipment is a Class 10. Since it is possible to burn out a motor in less than 20 seconds, we have chosen to protect the motor with the highest degree of protection.

Codes And Standards

NFPA 79—Electrical Standard for Industrial Machinery, 2002

7.3.1.1 Motors. Motor overload protection shall be provided to each motor in accordance with Article 430, Part III, of NFPA 70, *National Electrical Code*.

NEC 2002—National Electrical Code

430.32 (A) (1) Separate Overload Device. A separate overload device that is responsive to motor current. This device shall be rated at no more than the percentages shown in Table D-1.

Table D-1: Full Load Current Tolerances

	% Allowed Above Full Load Current Rating
Service Factor of 1.15	125%
Motors with a marked temperature rise of 40°C or less	125%
All other motors	115%

Example 1

15 hp, 208V, 3 phase, induction motor, 40°C rise, *design B, FLA* 48 amps. Overload Protection = 48 amps times 125% = 60 amps

Example 2

25 hp, 208V, 3 phase, induction motor, 1.15 s.f., *design C, FLA* 72A. Overload Protection = 72 amps times 125% = 90 amps

Example 3

40 hp, 208V, 3 phase, wound rotor motor, FLA 118 amps. Overload Protection = 118 amps times 115%=136 amps

The motor overloads must be calculated using the nameplate current and not from Tables 430-148 or 430-150 of the National Electrical Code.



In Example 1, the motor has a 40°C rise, the O.L. unit is sized at 125% of the full load motor current.

In Example 2, the motor has a s.f. (service factor) of 1.15. The O.L. unit is sized at 125% of the full load motor current.

In Example 3, where neither of the two conditions exists, it is sized at 115%.

Glossary of Overload Terms

Full Load Amps (FLA)

This is the current flow required by a motor during normal operation under normal loading to produce its designated horsepower. Motors having nothing attached to their shaft will draw less than the FLA current.

Insulation Class

The National Electrical Manufacturers Association (NEMA) has established insulation classes to meet motor temperature requirements found in different operating environments. The four insulation classes are A, B, F, and H. Class F is commonly used. Class A is seldom used. Before a motor is started, its windings are at the temperature of the surrounding air. This is known as ambient temperature. NEMA has standardized on an ambient temperature of 104°F, or 40°C for all motor classes.

Temperature rises in the motor as soon as it is started. The combination of ambient temperature and allowed temperature rise equals the maximum winding temperature in a motor. A margin is allowed for a point at the center of the motor's windings where the temperature is higher. This is referred to as the motor's hot spot.

The operating temperature of a motor is important to efficient operation and long life. Operating a motor above the limits of the insulation class reduces the motor life expectancy. A 50°F (10°C) increase in the operating temperature can decrease the life expectancy of a motor by as much as 50%.

Table D-2: Maximum Winding Temperature

Class A	Class B	Class F	Class H
221°F (105°C)	266°F (130°C)	311°F (155°C)	356°F (180°C)

Locked Rotor Amps

Also known as inrush current, locked rotor amps is the amount of current the motor can be expected to draw under starting conditions when full voltage is applied. This is the current taken from the supply line at rated voltage and frequency with the rotor at rest.

Motor Load

A motor provides the conversion of electrical energy to mechanical energy that enables a machine to do work. The energy that a machine requires from a motor is known as the

motor load. The motor load “seen” by a motor is dependant upon how the load is connected to the motor, the dimensions of the load, and the weight of the load.

A load connected to a motor by a gearbox reduces the load by the square of the gear ratio. If a load is attached to a motor through a 3:1 gear ratio, the load is 1/9 of the load the motor would see if the load were attached directly to the motor.

A round object attached to the motor shaft has a load related to the square of the radius of the object. If a 16" saw blade is a load of weight multiplied by the radius squared, the load is $8^2 \times \text{weight} = 64 \times \text{weight}$. A 20" saw blade is a load of $10^2 \times \text{weight} = 100 \times \text{weight}$. The 20" saw blade is 56% more load than the 16" saw blade due to the dimensions.

A motor load is directly related to the weight of an object. A 16" blade weighs 9.28 pounds. A 20" blade weighs 14.61 pounds, or 5.33 pounds more. The 20" blade is 56% more load than the 16" blade due to weight. Remember, weight is the volume of an object times its density, so weight is also related to the dimensions.

In the example of the saw blades, the combined effect of the longer radius, and longer weight means the 20" saw blade is approximately 125% more load on a motor than a 16" saw blade, which partially explains why motors on quads 1 and 4 are more likely to burn out or trip an overload.

NEMA Design Ratings

NEMA ratings refer to the torque ratings. The following ratings apply to motors:

NEMA B

The NEMA B motor's percentage of slip ranges from 2 to 4%. It has medium values for starting or locked rotor torque, and a high value of breakdown torque.

NEMA A

The NEMA A motor is similar in many ways to the NEMA B motor. It typically has a higher value of locked rotor torque and its slip can be higher.

NEMA C

The NEMA C motors are well suited to starting high-inertia loads. This is because they have high locked rotor torque capability. Their slip is around 5%, and their starting current requirement is average.

NEMA D

The NEMA D motor is found in heavy duty, high-inertia applications. It has high values of slip (up to 8%), and very high locked rotor torque capability.

Service Factor (s.f.)

A motor designed to operate at its nameplate horsepower rating has a service factor of 1.0. Some applications may require a motor to exceed the rated horsepower. In these cases a motor with a service factor of 1.15 can be specified. The service factor is a multiplier that may be applied to the rated power. A 1.15 service factor motor can be operated 15% higher than the motor's nameplate horsepower.

Trip Class

Overload relays are rated by a trip class, which defines the length of time it will take for the relay to trip in an overload condition. The most common trip classes are Class 10,

Figure D-3: Trip Times for Trip

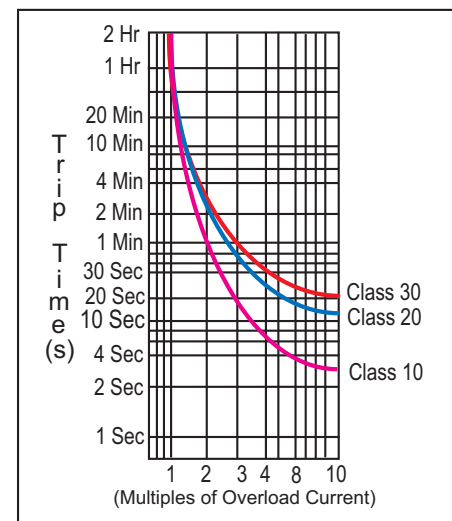

Class 20, and Class 30. Class 10, for example, has to trip the motor off-line in 10 seconds or less at 600% of the full load amps. This is usually sufficient time for the motor to reach full speed.

Understanding Motor Starting Problems

There are three major sources of motor starting problems: voltage source problems, control circuit problems, and drive faults. Diagnosing and resolving these problems can be a time-consuming process, but some time can be saved by using an organized process of elimination. The following sections address the most common sources of motor starter problems.

WARNING	
	<p>ELECTROCUTION HAZARD.</p> <p>Always turn the power off by activating an E-stop when the equipment is not in operation.</p> <p>Always verify that all power to the machine has been turned off and follow approved lockout/tagout safety procedures (OSHA 29 CFR 1910.147) before performing any maintenance on this equipment.</p> <p>If it is absolutely necessary to troubleshoot an energized machine, follow NFPA 70E for proper procedures and personal protective equipment.</p>

Voltage Source Problems

1. Check the incoming power source. Verify that all three phases of power have the proper voltage using a digital multimeter set to voltage mode. If any of the three phases of incoming power are low or missing, disconnect power at the primary disconnect switch and reset the circuit breaker or replace the fuse.
2. Before restoring power at the primary disconnect, verify that there are no phase-to-phase or phase-to-ground shorts at the motor starter line contactors. If necessary, replace starter contacts to correct shorts.
3. Check that motor thermal overloads have not been tripped. Reset the overloads by pressing the reset pushbutton.
4. Check the motor starter leads for phase-to-phase and phase-to-ground shorts. Check for discoloration, hot spots, melted wire or damaged fuses. Correct the motor lead wiring if necessary.

5. Check the motor leads for phase-to-phase and phase-to-ground shorts. Check for discoloration, hot spots, melted wire or damaged fuses. Replace the motor if necessary.
6. Determine if motor windings are breaking down by testing the motor insulation with an insulation tester or taking the motor to a repair shop for testing.
7. Disconnect the motor from its load. Start the motor. If it runs correctly, the problem is associated with the mechanical drive train. If it does not run correctly, replace the motor bearings.

Control Circuit Problems

1. If the incoming power source has all three phases of power, check the motor starter overloads. Reset the motor starter overloads by pressing the reset button.
2. Verify that the control voltage transformer fuse is operating correctly using a digital multimeter set to Ohms. The multimeter should have a low reading. If the multimeter registers no reading or an infinite reading, replace the fuse.
3. Disconnect the motor starter contactor coil. Check for a short or ground. If necessary, replace the motor starter coil.
4. Check the control circuit wiring to the contactor coil while the coil is still disconnected. If a short or ground is present, disconnect the field wiring circuit to the motor starter. Determine whether the problem is with the motor contactor overload circuit or the field control wiring.
5. If a ground is found in the motor starter overloads circuit, replace the overloads. Reconnect the starter coil and control field wiring.
6. If a ground is found in the field wiring circuit, clear the ground. Reconnect the starter coil and control field wiring.
7. Check for an open circuit in the motor overloads or control circuit by using a digital multimeter set for Ohms to verify the motor overloads control circuit is working correctly.
8. Check the PLC contact closure, relay contact closure or start/stop pushbutton circuit that supplies the start signal to the motor starter.

Drive Faults

Before troubleshooting a drive fault, determine whether the fault is a motor, drive, or application fault. Use the fault codes of the drive. If you are unable to locate the source of the fault, contact MiTek Customer Service.

Drawings are inserted at the back of the manual.

Table E-1: Attached Drawings

	Drawing Number
Gantry	30001-501
Table assembly, 30' U-channel	30002-501
Gantry mechanical assembly	30003-501
Hydraulic assembly	30005-501
Trolley assembly	30006-501
Support assembly	30010-501
Festoon assembly	30067-501
Table assembly, 30' solid top	30084-501
Hydraulic power assembly, 50-ton	30096-501
Hose and fittings kit, 50-ton	30102
Electrical schematic	90601
Enclosure cutouts	90601-102
Joystick enclosure	90601-103
Electrical assembly	90601-501
Main enclosure	90601-502
Operator controls	90601-503
Power distribution enclosure	90601-504
Dual-control option	90601-603



Document Evaluation

Appendix F

A form is included in this appendix so you can provide MiTek with feedback on the usefulness of this manual. We make an ongoing effort to improve the value of our documentation, and your views are important to us.

Please follow the instructions on the form to provide us with comments or suggestions that will help us improve the quality of our documentation services.

Document Evaluation Form (cont'd)

Identify any inaccuracies in the document.

What are the three best features of the document?

What are the three worst features of the document?

What did you like/dislike about the illustrations?

Your Name:

Date:

Company Name:

Address:

Phone:

Email:

Please mail this form to:

MiTek
Machinery Operations
301 Fountain Lakes Industrial Drive
St. Charles, MO 63301
Attn: Engineering Manager

Or fax this form to:

636-328-9218
Attn: Engineering Manager

If you do not receive a reply within 45 days, please call our Customer Service Department and ask for the Documentation Specialist or Engineering Manager: 800-523-3380.

Glossary

actuate	to activate, put into action
amperage	the strength of an electric current, expressed in amperes
anchor plate	a steel plate that holds the tables in place; it is anchored to the concrete floor
bumper	a safety device that prevents the gantry from crashing into the edge of the table
connector plate	the nail-plate that is embedded into the production material to hold it together
gantry head	the entire traveling weldment that houses the platen to embed the connector plates
jigging	any of several devices used to hold the truss in place on the tables
joystick	an option that controls the left and right movement of the gantry head
layout	a scaled diagram of the location of components and the space that they occupy
lockout/tagout	a means of isolating a piece of equipment from its energy source so maintenance can safely occur; guidelines provided in OSHA 29 CFR 1910.147
operator control interface	the method in which the operator controls the machine; it may be a touch screen, a control panel, etc.
plate	see <i>connector plate</i>
port	a connection point for a peripheral device
puck	a type of jigging that is small and round

Glossary

qualified person	a person or persons who, by possession of a recognized degree or certificate of professional training, or who, by extensive knowledge, training, or experience, has successfully demonstrated the ability to solve problems relating to the subject matter and work—ANSI B30.2-1983; one who has skills and knowledge related to the construction and operation of the electrical equipment and installations and has received safety training on the hazards involved—NEC2002 Handbook
solenoid	an assembly used as a switch consisting of a coil and a metal core free to slide along the coil axis under the influence of the magnetic field
stop	a type of jigging that is long and straight
torque	a turning or twisting force
voltage	Equal to the difference of electric potential between two point on a conducting wire carrying a constant current of one ampere when the power between the points is one watt

Index

B

bearings
 lubrication 39, 40
 motor 53
blocking 7, 65, 66
bumpers 67

C

caution logo ix
centerlines 8
chains
 adjusting tension 60
 drive wheel 60, 61
 lubrication 60
 master link 61
checklists
 installation 23
 maintenance 79
cleaning
 general 39
 motors 68
components
 main 6
 options 6
contact information 3
Customer Service 3
customer-supplied parts
 electrical 16
 transport equipment 16
cylinders
 hydraulic 31
 replacing 48

D

danger logo ix
delivery 17
 inspecting 17
 unloading 18
 unpacking 19
dimensions 13
disconnect switch 27
document evaluation form 97

drawing set 95

E

electrical
 checking voltage 71
 components 68
 customer-supplied parts 16
 installation 22
 requirements 14
emergency stops, *see* E-stop
environment 13
environmental logo ix
equipment, transport 16
E-stop
 disconnect switch 27
 location 26
 pushbutton 26

F

filter, hydraulic system
 location 42
 replacing 42
floor requirements 13
fluid, hydraulic
 adding and replacing 41
 specifications 41

H

hazard indicator ix
heater 6
HPU (hydraulic power unit)
 electrical connections 21
 replacing pump and motor 50
hydraulic power unit, *see* HPU
hydraulic system
 components 44
 cylinders 48
 filter 42
 fluid
 adding 41
 changing 42

Index

- specifications 41
- motor 47
- pump 44, 49

I

- installation
 - checklist 23
 - customer responsibilities 11
 - delivery 17
 - electrical 22
 - hydraulic system 21

J

- jigging
 - blocking 65
 - maintenance 40
 - U-channel 4, 65

L

- layout 12
- lockout/tagout
 - graphic 2, 33
 - guidelines xii
 - procedure xiii, xv, xxv, xxvii
- lubrication
 - bearings 39
 - chains 40, 60
 - general 39

M

- maintenance
 - checklists 79
 - safety during 33
 - space required 13
- manual
 - introduction 1
 - navigation 2
 - purpose 1
- master link 61
- motor drive chain

- adjusting tension 60
- lubrication 60

- motors
 - changing rotation 24
 - overloads 68
 - starters 68
- multimeter 71

N

- notice logo ix
- notice of change iii

O

- oil, hydraulic, *see* fluid, hydraulic
- options 6

P

- page change iii
- parts list 76
- pre-installation requirements
 - customer-supplied parts 11
 - electrical 14, 16
 - space 12, 13
 - transport equipment 16

R

- replacement parts 76
- reporting errors ii
- restricted zones xvii, xxx
- return goods ii

S

- safety
 - during troubleshooting 69
 - lockout/tagout xii, 2
 - restricted zones xvii, xxx
 - safety indicators ix
 - safety rules ix, xx

Index

tests xviii
shipping information 15
space
 for equipment 13
 for maintenance 13
 for operation 13
spare parts, *see* replacement parts
specifications
 features 6
 general 7
stop motion, *see* E-stop

T

training 16
truss terminology 8

U

unloading 18
unpacking 19

W

warning logo ix
weight 15

2" binder

*Jack Table*TM

**Platen Press
Equipment Manual**



001094

1/2" binder

*Jack Table*TM

**Platen Press
Equipment Manual**



001094

1-1/2" binder

*Jack Table*TM

**Platen Press
Equipment Manual**



001094

1" binder

*Jack Table*TM

**Platen Press
Equipment Manual**



001094

